

REMKO ML

ML 262 DC, ML 352 DC, ML 522 DC

*Inverter wall mounted units in split design
and frost protection function*

Operation · Technology · Spare parts



Contents



<i>Safety notes</i>	4
<i>Warranty</i>	4
<i>Environmental protection and recycling</i>	4
<i>Intended use</i>	4
<i>Transport and packaging</i>	5
<i>Equipment description</i>	5
<i>Operation</i>	6-12
<i>Decommissioning</i>	12
<i>Care and maintenance</i>	12-13
<i>Troubleshooting and customer service</i>	14-15
<i>Installation instructions for qualified personnel</i>	15-18
<i>Installation</i>	18-19
<i>Monitoring for leaks</i>	20
<i>Condensate drain</i>	20
<i>Electrical connection</i>	20-21
<i>Electrical connection diagram</i>	21
<i>Electrical circuit diagram</i>	22-23
<i>Before commissioning</i>	24
<i>Add refrigerant</i>	24
<i>Commissioning</i>	24-25
<i>Unit dimensions</i>	25
<i>Exploded view</i>	26-27
<i>Spare parts list</i>	26-27
<i>Performance datas</i>	28-29
<i>Technical data</i>	30
<i>EC-Declaration Conformity</i>	31



Read these operating instructions carefully before commissioning / using the device!
These instructions are an integral part of the system and must always be kept near or on the device.
This operating manual is a translation of the German original, Version W-07

Subject to modifications; No liability accepted for errors or misprints!

Safety notes

Carefully read this manual before putting commissioning the equipment. It provides useful tips and information  as well as hazard warnings to prevent injury or material damage . Failure to follow the directions in this manual can result in endangerment to persons, the environment and the equipment itself and will void any claims for liability.

- Keep this manual and the refrigerant datasheet near the unit.
- The unit may only be set up and installed by qualified personnel.
- The setup, connection and operation of the unit and its components must be in accordance with the operating conditions stipulated in this manual and comply with all applicable local regulations.
- Mobile units must be set up securely on suitable surfaces and in an upright position. Stationary units must be permanently installed for operation.
- Modification of equipment and components supplied by REMKO is not permitted and can cause malfunctions.
- Equipment and components may not be operated in areas where there is an increased risk of damage. Observe the minimum clearances.
- The electrical voltage supply is to be adapted to the requirements of the equipment.
- The operational safety of equipment and components is only assured if they are used as intended and fully assembled. Safety devices may not be modified or bypassed.

- Do not operate equipment or components with obvious defects or signs of damage.
- All housing parts and openings, e.g. air inlets and outlets, must be free of foreign objects, fluids or gases.
- The equipment and components must be kept an adequate distance from flammable, explosive, combustible, aggressive and dirty areas or atmospheres.
- Touching equipment parts can result in burns or injury.
- Installation, repair and maintenance work may only be carried out by authorised specialists. Visual inspections and cleaning can be performed by the operator as long as the equipment is not under voltage.
- Take appropriate hazard prevention measures when performing installation, repair or maintenance work or cleaning the equipment.
- The equipment or components are not to be exposed to any mechanical stresses, extreme levels of humidity or direct sunlight.

Warranty

Prerequisite for any warranty claims are that the purchaser or their customer has completely filled out the "warranty registration card" and commissioning report included with the unit at the time when the equipment was purchased and first put into operation and returned it to REMKO GmbH & Co. KG. The warranty conditions are listed in the "General Business and Delivery Conditions". Only the contractual parties can strike special agreements beyond these conditions. For this reason please first contact your direct contractual partner.



Environmental protection and recycling

Disposal of packaging

All products are packed for transport in environmentally friendly materials. Make a valuable contribution to reducing waste and sustaining raw materials. Only dispose of packaging at approved collection points.



Disposal of equipment and components

Only recyclable materials are used in the manufacture of the devices and components, Help protect the environment by ensuring that the devices or components (for example batteries) are not disposed in household waste, but only in accordance with local regulations and in an environmentally safe manner, e.g. through authorised disposal and recycling specialists or at collection points.

Intended use

Depending on the model, the equipment and the additional fittings with which it is equipped is only intended to be used as an air-conditioner for the purpose of cooling or heating the air in an enclosed room.

Different or additional use shall not be classed as intended use. The manufacturer/supplier assumes no liability for damages arising from an unintended use of the equipment. The user bears the sole risk in such cases.

Using the equipment as intended also includes working in accordance with the operating manual and installation instructions and complying with the maintenance requirements.

Transport and Packaging

The equipment is shipped in sturdy transport packaging. Immediately check the equipment on delivery and make note of any damage or missing parts on the delivery note and inform the forwarding agent and your contractual partner. No warranty can be assumed for later claims.

Equipment description

The ML 262-522DC room air conditioning units have a REMKO ML...DC AT outdoor component as well as an ML...DC IT indoor unit.

When in cooling mode, the outdoor component serves to release the heat extracted by the indoor unit from the room being cooled. **When in heating mode, the heat absorbed by the outdoor component can be released by the indoor unit into the room being heated.** In both operating modes, the performance of the compressor adjusts itself precisely to the demand, thereby regulating the target temperature with minimal temperature fluctuations. This "inverter-technology" results in energy savings over conventional split systems and also reduces noise emissions to a particularly low level. The outdoor component can be installed outdoors or indoors providing that certain requirements are met. The indoor unit is designed to be mounted high up on indoor walls. Operation takes place using an infrared remote control.

The outdoor component consists of a refrigerant circuit with compressor, fin condenser, condenser fan, reverse flow valve and throttle element. The outdoor component is controlled via the regulation of the indoor unit.

The indoor unit consists of a fin vaporiser, vaporiser fan, regulation system and condensation pan.

Floor consoles, wall consoles, refrigerant pipes and condensation pumps are available as accessories.

Refrigerant circuit diagram for the outdoor component

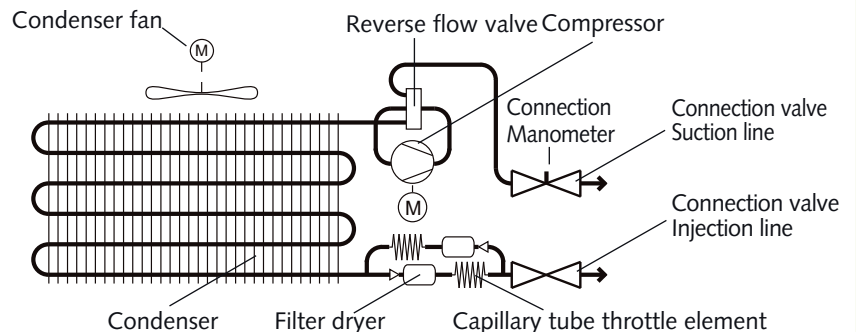

Refrigerant circuit diagram for the indoor unit

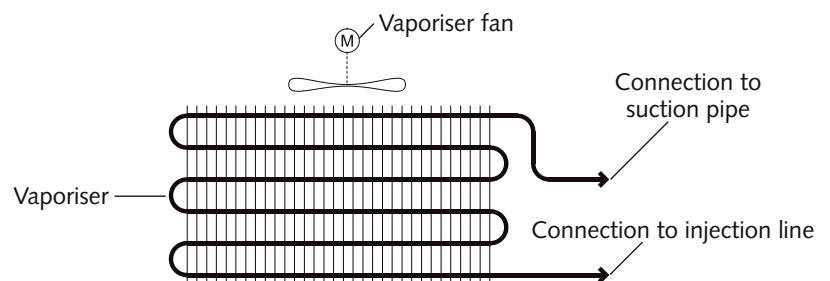

System configuration

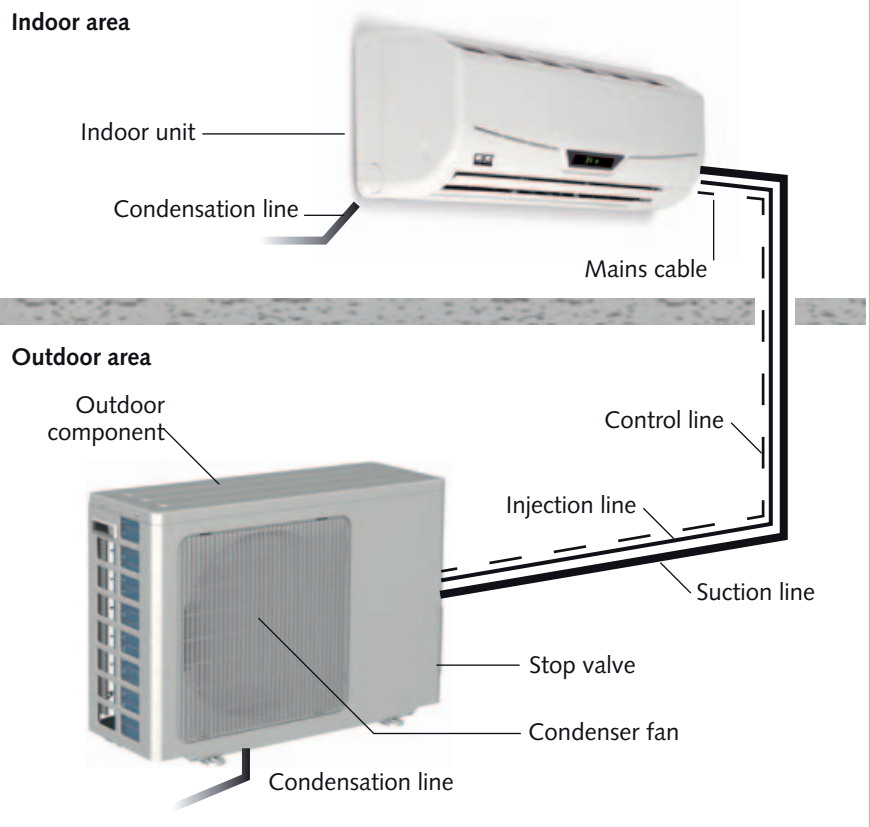

The connection between the indoor unit and the outdoor component is made by way of the refrigerant lines.

REMKO ML...DC

Operation

The indoor unit is easily operated using the standard infrared remote control. The indoor unit beeps to acknowledge the correct transmission of data. If it is not possible to program the indoor unit using the remote control, it can also be manually operated.

Manual operation

The indoor units can be commissioned manually. After the air inlet screen has been opened, the inner recessed button can be pressed and automatic mode can be activated.

In manual operation, the following settings apply:

Cooling mode: last setting
Fan speed: AUTO
Heating mode: last setting
Fan: AUTO

Press the button on the infra-red remote control to interrupt manual operation.

Display on indoor unit

The display illuminates according to the settings.

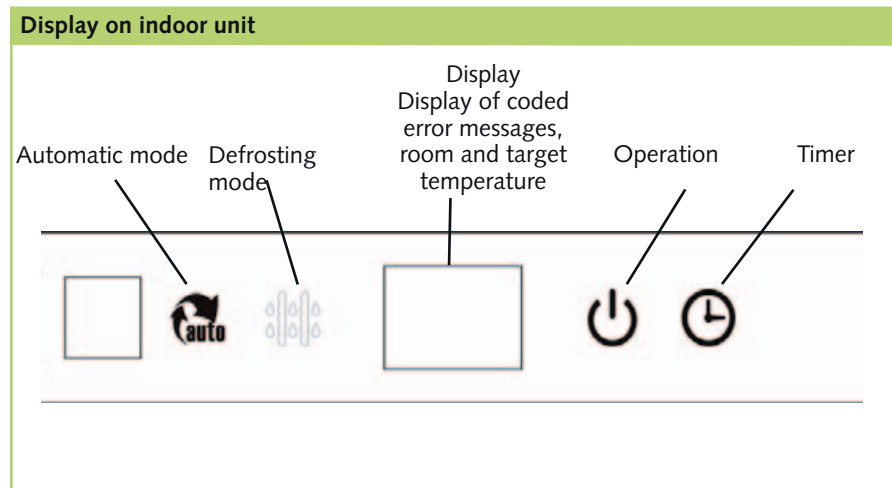

Infrared remote control

The infrared remote control sends the programmed settings over a distance of up to 6 m to the receiver of the indoor unit. Data will only be received correctly if the remote control is pointed at the receiver and no objects obstruct the transmission path.

First insert the batteries supplied at delivery (2 x type AAA) into the remote control. To do so, remove the cover of the battery compartment and insert the batteries as indicated according to their polarisation (see markings).



CAUTION

Faults are shown in code (See chapter fault remedy and customer service)

NOTE

Replace discharged batteries immediately with a new set in order to avoid the danger of leakage. It is recommended that the batteries are removed if the equipment is shut down for longer periods.

Buttons on the remote control

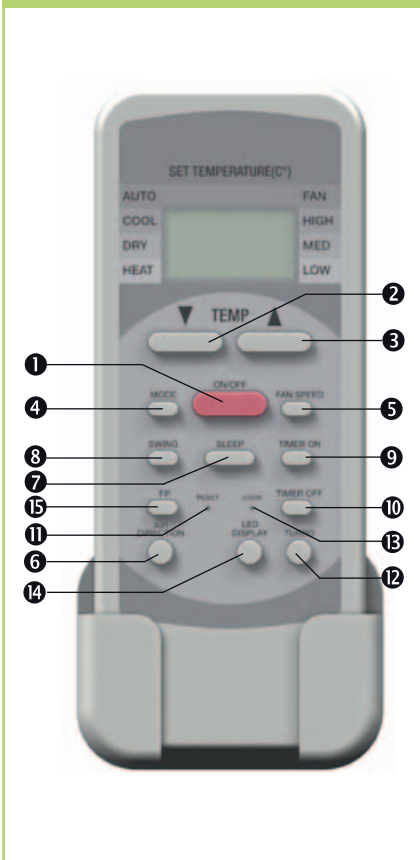

Buttons on the remote control

1 "ON/OFF" Button

Press this button to start the unit.

2 "▼" button

This button is used to reduce the desired temperature to as low as 17 °C.

3 "▲" button

This button is used to increase the desired temperature to up to 30 °C.

4 "MODE" button

Use this button to select the operating mode. The indoor unit has 4 modes:

1. Automatic mode

In this mode, the unit works in cooling or in heating mode.

2. Cooling mode

In this mode, the warm room air is cooled to the desired temperature.

3. Dehumidification mode

In this mode the room is mainly dehumidified and the adjusted temperature is maintained.

4. Heating mode

In this mode, the warm air in the room is heated up to the desired temperature.

5. Circulation mode

In this mode, the air in the room is circulated with no change in temperature.

5 "FAN" button

Press this button to set the desired fan speed. 4 speeds are available: Automatic, high, medium and low fan speed.

6 "AIR DIRECTION" button

This button sets the desired fin position of the exhaust fins. Various fixed positions and an oscillating function are available.

7 Button "SLEEP"

After pressing this button, the target temperature in cooling mode automatically increases by 1 °C within one hour. In heating mode, the target temperature is reduced by 1 °C within one hour.

8 "SWING" button

This button directly activates the oscillating function of the fins for better air distribution in the room.

9 "TIMER ON" button

This button is used to program the time at which the unit is automatically activated in

30 minute intervals within the following 24 hours.

"TIMER OFF" button

This button serves to program the automatic shut-off time in 0.5 h intervals within the following 24 hours.

11 "RESET" button

This button resets the remote control to its factory default configuration.

12 "TURBO" button

The TURBO function activates the maximum fan speed and the compressor.

13 "Lock" button

This button can be used to lock the remote control's keys. An unintentional adjustment can be prevented.

14 "LED DISPLAY" button

This button switches the display on and off (no influence on unit function)

15 "FP" button

This button activates the "frost protection function", which sets the nominal temperature in heating mode to 8°C. This function is used to guaranteed frost protection in unsupervised rooms. When the FP function is active, the device switches heating mode on and at 10°C switches it off again.

This serves to ensure that the frost protection limit is not reached. If "FP" mode is activated, this is indicated in the display.

Pressing "ON/OFF", "MODE", "FAN", "TEMP ▲ ▼" "TIMER ON/OFF", "FP" will quit the function.

REMKO ML...DC

Remote control display

Indicator arrows will be displayed according to the settings.

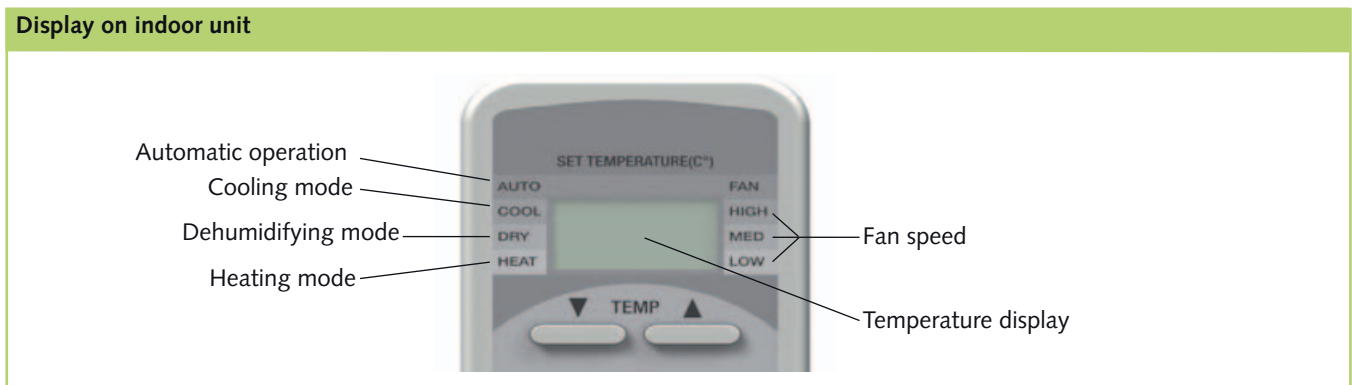

Button functions

A symbol is shown on the display to indicate that the settings are being transferred.

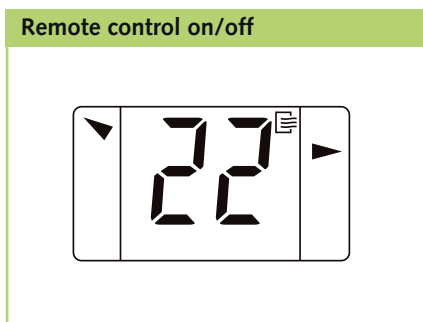

The remote control's on/off function is shown at the upper right of the remote control by a "wind symbol".

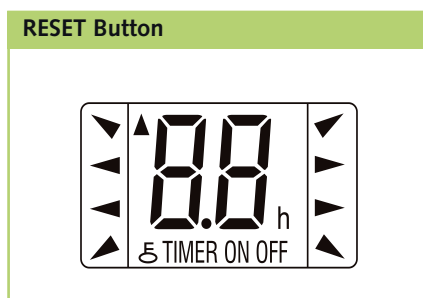

The remote control can be reset by pressing the (counter sunk) RESET button.

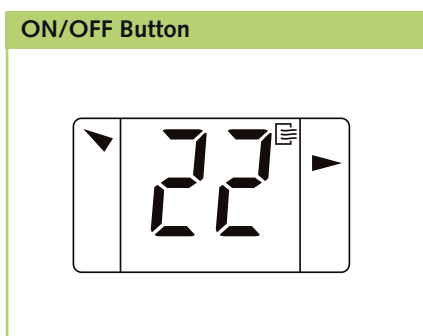

Your air-conditioner is activated and deactivated by pressing the ON / OFF button. The programmed settings and adjustment values before the unit was turned off will appear on the display.

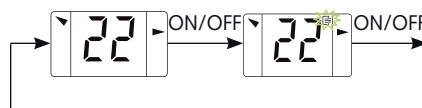

▲/▼ Buttons

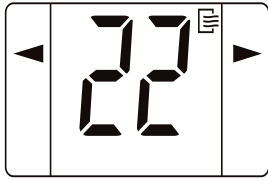

Using the button, the target temperature can be adjusted up or down by 1°C. The temperature range lies between 17°C and 30°C

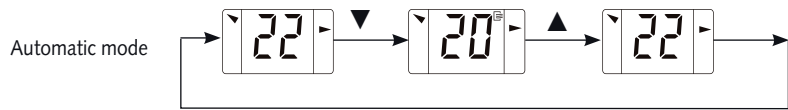

MODE Button

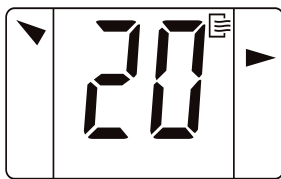

Use the MODE button to select between individual operating modes. 5 modes are available:

1. Automatic cooling or heating operation
2. Cooling predominant operating mode for summer
3. Dehumidifying operating mode for summer or winter
4. Heating predominant operating mode in winter
5. Circulation air circulation only

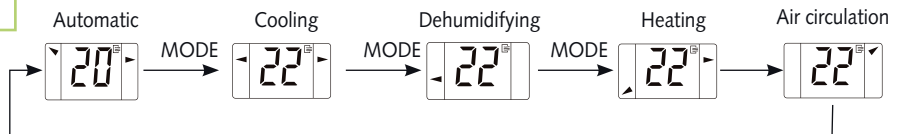

AUTOMATIC MODE

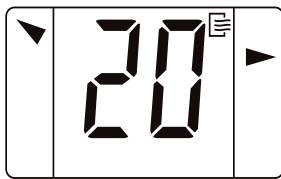

In automatic mode, the controller autonomously selects between heating and cooling operation when the unit is first switched on. The control range lies between 22 °C and 26 °C. This can be increased or decreased with the ▲/▼ buttons. Fan speed is selected automatically.



COOLING mode

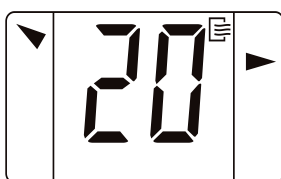

In cooling mode, the air in the room is cooled down to the set target temperature. The desired room temperature is set with the ▲/▼ buttons in 1 °C increments. If the room temperature is 0.5 °C above the selected nominal temperature, then the interior unit starts to cool down the air in the room. If the temperature falls to approx. 1 °C below the set room temperature, the controller will switch off the cooling function. To protect the compressor, the controller will not switch off the cooling again until after a waiting period of 3 minutes.



REMKO ML...DC

DEHUMIDIFICATION MODE



It is recommended that the target temperature be set to 24 ° in dehumidifying mode. Due to the low temperature of the refrigerant, the dew point of the air at the condenser is undercut. The excess moisture in the air is condensed by the vaporiser, the room is dehumidified. The fan speed is permanently set to the lowest setting in order to achieve a maximum level of dehumidification. The compressor switches on and off in intervals between 17°C and 24°C.

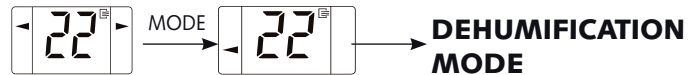

HEATING Mode

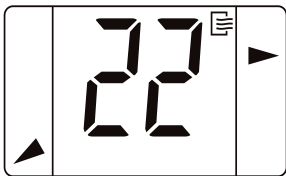

In the heating mode, you can heat the room in spring or fall. The selected room temperature is set using the ▲/▼ buttons in 1 °C increments. If the room temperature is 1 °C below the selected target temperature, the indoor unit starts to heat the air in the room. If the set room temperature is exceeded by approx. 1 °C, the controller will switch off the heater function. To protect the compressor, the controller will wait 3 minutes before switching on the heating mode again.



FAN SPEED Button



The fan speed can be adjusted with this button. A selection can be made between low, medium, high and automatic fan speed.

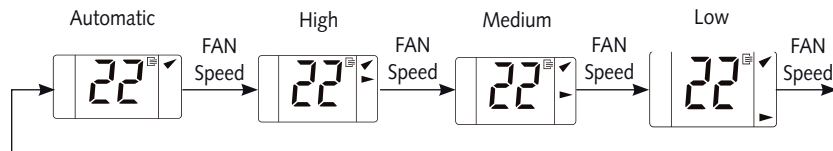

AIR DIRECTION Button



The air discharge fins are individually adjusted using this button. Various positions and an oscillating function can be selected.

SWING Button



The oscillating function of the air discharge fins can be adjusted with this button. This makes it possible to switch directly between a preset position and the oscillating function. The air distribution in the room is improved using the swing function.

SLEEP Button



A programming function is activated using this button, which increases the target temperature in cooling mode by 1 °C after one hour and by 2 °C after 2 hours. In heating mode, the target temperature is decreased by 1 °C after one hour by 2 °C after 2 hours. The unit switches off automatically after 8 hours.

TIMER Button



The activation and switch-off time can be programmed with this button. The timer is activated and the time display is switched off by pressing the Timer on or Timer off button. The timer display on the indoor unit illuminates. The desired activation or deactivation time is set by pressing the Timer On or Timer Off buttons. When the programmed time has been reached, the device automatically switches on or off. If the indoor unit is automatically switched on, the mode, temperature and fan speed for the last setting are activated. Deleting the preset on and off time early is carried out by pressing the ON/OFF button. The timer display on the indoor unit goes out.

TIMER ON Button

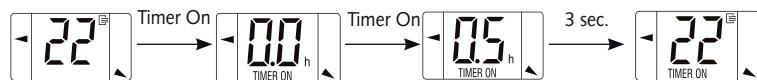

TIMER OFF Button

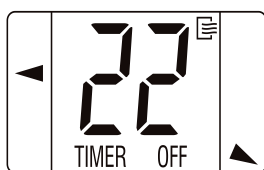

"FP" Button



This button activates the „frost protection function“, which sets the nominal temperature in heating mode to 8°C. This function is used to guaranteed frost protection in unsupervised rooms. When the FP function is active, the device switches heating mode on and at 10°C switches it off again. This serves to ensure that the frost protection limit is not reached. If „FP“ mode is activated, this is indicated in the display.

Pressing „ON/OFF“, „MODE“, „FAN“, „TEMP ▲ ▼“, „TIMER ON/OFF“, „FP“ will quit the function.



REMKO ML...DC

Manual air distribution

There are individually adjustable fins for adjusting the horizontal air distribution on the air discharge side.

⚠ ATTENTION

Moving, internal parts, e.g. fans, have the potential to cause injury during operation! Only make adjustments after swing operation has been switched off.

Decommissioning

Temporary Decommissioning

1. Allow the indoor unit to run for 2 to 3 hours in air circulation mode or in cooling mode at the maximum temperature setting in order to remove any residual moisture from the unit.
2. Shut down the unit using the remote control.
3. Switch off the voltage supply to the unit.
4. Cover the unit as far as possible with plastic foil in order to protect it from the influences of weather.

Permanent Shutdown

Ensure that equipment and components are disposed of in accordance with local regulations, e.g. through authorised disposal and recycling specialists or at collection points.

REMKO GmbH & Co. KG or your contractual partner will be pleased to provide a list of specialist companies near you.

Manual air distribution



Shift lever left

Shift lever right

Care and maintenance

Regular care and maintenance serves to ensure trouble-free operation and long service life of the unit.

⚠ ATTENTION

Prior to performing any work, ensure the equipment is disconnected from the voltage supply and secured to prevent accidental switch-on!

Care

- Ensure the indoor unit and outdoor component are protected against dirt, mould and other deposits.
- Clean the equipment using a damp cloth. Do not use any caustic, abrasive or solvent-based cleaning products. Do not use a jet of water.
- Clean the fins on the indoor unit and outdoor component prior to long shutdown periods.

Maintenance

- We recommend concluding a maintenance contract with annual service from an appropriate specialty company.

💡 TIP

This ensures the operational reliability of your system!

💡 NOTE

Statutory regulations require an annual leak test for the refrigerant circuit in relation to the refrigerant filling capacity. Inspection and documentation is to be carried out by specialty technicians.

Cleaning the housing of the indoor unit

1. Disconnect the supply voltage to the equipment.
2. Open and fold the air inlet guard on the front side upwards.
3. Clean the guard and cover using a soft, damp cloth.
4. Switch the supply voltage back on.

Air filter for indoor unit

Clean the air filter at intervals of no more than 2 weeks. Reduce this interval in case of heavily soiled air.

Cleaning the filter of the indoor unit

1. Disconnect the supply voltage to the equipment.
2. Open the front side of the device by folding the guard upwards and allowing it to engage (**figure 1**).
3. Raise the filter and pull it out pulling downwards.
4. Clean the filter with a standard vacuum cleaner. Turn the dirty side upward (**figure 2**).
5. Dirt can also be removed by carefully cleaning with lukewarm water and mild cleaning agents. Turn the dirty side downwards(**figure 3**).

Type of task	Commissioning	Monthly	Six-monthly	Yearly
Checks/Maintenance/Inspections				
General	•			•
Measure voltage and current	•			•
Check function of compressor/fans	•			•
Check fan function	•			•
Dirt on condenser/vaporiser	•	•		
Check refrigerant fill quantity	•		•	
Check condensation drain	•		•	
Test insulation	•			•
Check moving parts	•			•
Sealing test for refrigerant circuit	•			• ¹⁾

1) see note

6. If water is used, let the filter dry out before replacing it in the unit.
7. Carefully insert the filter. Make sure it is seated correctly.
8. Close the front side as described above in reverse order.
9. Switch the supply voltage back on.
10. Switch the unit on again.

Cleaning the condensation pump (accessories)

An optional integrated or separate condensation pump may be included with the indoor unit, which pumps out any accumulated condensation into higher positioned drains. Observe the care and maintenance instructions given in the separate operating instruction manual.

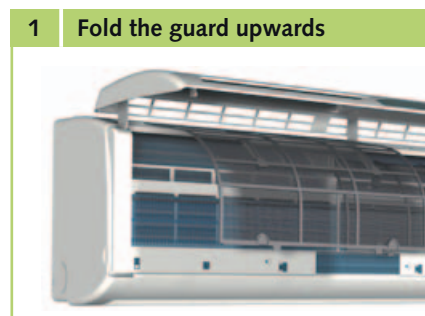

Troubleshooting and customer service

The equipment and components are manufactured using state-of-the-art production methods and tested several times to verify their correct function. If malfunctions should occur, please check the functions as detailed in the list below. Please inform your dealer if the unit is still not working correctly after all the functional checks have been performed!

Fault

Fault	Possible cause	Checks	Remedial measures
The unit does not start or switches itself off continually	Power outage, undervoltage, defective mains fuse / main switch in off position	Are all other electrical installations functioning correctly?	Check voltage if necessary wait until turned on again.
	Damaged mains cable	Are all other electrical installations functioning correctly?	Repair by a specialist
	Wait time after switching on is too short	Have approx. 5 minutes elapsed since the restart?	Schedule longer waiting periods
	Working temperature undercut / exceeded	Are the fans in the indoor unit and outdoor component working correctly?	Take into account the temperature range for the indoor unit and outdoor component
	Electrical surges caused by thunder storms	Have there been lightning strikes in the area recently?	Switch off the mains protection and switch it on again / Have it inspected by a specialist
	Fault in external condensation pump	Did the pump shut down due to a fault?	Check and if necessary clean the pump
The unit does not respond to the remote control	Transmission distance too far / receiver affected by interference	Does the indoor unit beep when pressing a button?	Reduce the distance to less than 6 m or change position
	Defective remote control	Is the unit running in manual mode?	Replace the remote control
	Receiver or transmitter unit exposed to excessive solar radiation	Does it function correctly in the shade?	Place the receiver&transmitter unit in the shade
	Electromagnetic fields are interfering with transmission	Does it function after removing potential fault sources?	Signal is not transmitted when interference sources are operational
	Button on remote control jammed / two buttons pressed at same time	Does the "Send" symbol appear on the display?	Release the button / press only one button
	Batteries in remote control are flat	Have new batteries been inserted? Is the display incomplete?	Insert new batteries
The unit is running with reduced or without cooling or heating output	Filter is unclean / air inlet / outlet blocked by foreign objects	Have the filters been cleaned?	Clean the filters
	Windows and doors open. Heating/cooling loads increased	Have there been any constructional / application-related changes?	Close windows and doors / install additional units
	Neither cooling nor heating mode has been set up	Is the cooling/heating symbol activated in the display?	Correct the settings for the unit
	Fins on outdoor component blocked by foreign objects	Is the fan on the outdoor component running and are the fins unobstructed?	Check the fan or winter controller, reduce the air resistance
	Leaking refrigerant circuit	Are there signs of frost on the fins of the indoor unit?	Repair by specialist
Condensation is leaking out	Collection container drainage pipe blocked / damaged	Is unrestricted condensation discharge ensured?	Cleaning of drain pipe and collector reservoir.
	Faulty external condensation pump or float	Is the condensation tray full and the pump running?	Call out a specialist to replace the pump
	Condensation has collected in the condensation pipe	Has the condensation pipe been laid on a slope and is not blocked?	Lay the condensation pipe on a slope and clean if necessary
	Condensation does not drain off	Are the condensation lines unblocked and laid on a slope? Are the condensation pump and float switch functioning correctly?	Install the condensation pipe on a slope and clean if necessary / is the float switch or the condensation pump defective?

Problem display by blinker code

Display	Cause	Required action
E0	EEPROM error	Contact specialty company
E1	Communication error between outdoor component and indoor unit	Disconnect from mains for 2 min, check wiring
E2	Wiring fault L/N/Pe/S	Check wiring, replace IT circuit board
E3	Vaporiser fan speed too low	Check wiring, check motor voltage
E5	Outdoor temp. sensor / condenser temperature fault / short-circuited	Check wiring, contact specialty company
E6	air circulation sensor / vaporiser faulty / short-circuited	Check wiring, contact specialty company
P0	IGBT electrical surge protection	Check wiring, check compressor wiring contact specialty company
P1	Electrical surge / Undervoltage protection	Check voltage on the L/N/S system. Switch off and turn on again
P2	Excessive compressor temperature protection (Klixon) has tripped	Check refrigerant quantity, wiring, Klixon
P4	IPM power board safety shutdown	Check wiring, switch off and on again, contact specialty company

Installation instructions for qualified personnel

Important notes prior to installation

- Transport the unit in its original packaging as close as possible to the installation location. You avoid transport damages by doing so.
- Check the contents of the packaging for completeness and check the unit for visible transport damage. Report any damage immediately to your contractual partner and the shipping company.
- Lift the unit at the corners and not by the refrigerant or condensation connections.
- The refrigerant pipes (injection and suction line), valves and connections must be insulated against vapour diffusion. If necessary, also insulate the condensation pipe.
- Select an installation location which allows air to freely flow through the inlet and outlet. (See section "Minimum clearances").
- Do not install the unit in the immediate vicinity of devices with intensive thermal radiation. Installation near sources of thermal radiation reduces the output of the unit.
- Only open the shut-off valves of the refrigerant lines after the installation is complete.
- Seal off open refrigerant lines with suitable caps or adhesive strips to avoid infiltration of moisture and never kink or compress the refrigerant lines.
- Avoid unnecessary bends. You thereby minimize loss of pressure in the refrigerant lines and ensure clear return flow of the compressor oil.
- Take special precautions with regard to the oil return if the exterior component is located above the indoor unit. See section "Oil return flow measures".
- If the basic length of the refrigerant line exceeds 5 metres, add refrigerant. The quantity of additional refrigerant is provided in the chapter "Add refrigerant".
- Only use the union nuts for the refrigerant pipes included in the delivery, and remove them only shortly before connecting the refrigerant lines.
- Make electrical connections in accordance with the effective DIN and VDE standards.
- Always fasten electric cables properly to the electrical terminals. Otherwise a fire could result.

REMKO ML...DC

Wall openings

- A wall opening of at least 70 mm diameter and 10 mm slope from the inside to the outside must be made for each indoor unit
- We recommend that the inside of the opening is padded or lined, e.g. using a PVC pipe, to prevent the lines being damaged.
- After installation, the wall opening should be closed off with a suitable sealant. Do not use materials containing cement or lime!

Lines in the wall throughput

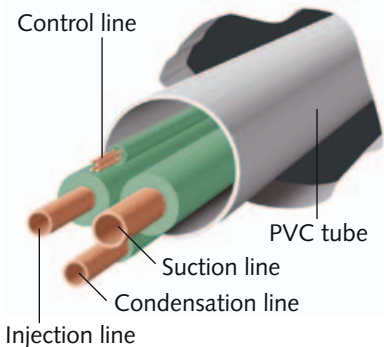

Installation material

The indoor unit is fastened using a wall bracket and 4 threaded screws (provided by the customer).

The outdoor component is attached to the wall with 4 screws and a wall bracket or on a pedestal secured to the ground.

Selection of the installation location

Interior unit

The indoor unit is designed for horizontal wall installation above doors. However, it can also be used on the upper wall area can be used (min. 1.75 m above the surface of the floor).

Outdoor component

The outdoor component is designed for horizontal installation on a base in outdoor areas. It should be placed on level, flat and firm surface. The unit should also be secured against tipping over. The outdoor component can be set up outside as well as inside a building. For external installation, please observe the following notes to protect the unit from weather conditions.

Rain

The unit should be at least 10 cm off the ground when mounted on the roof or ground. A pedestal is available as an accessory.

Sun

The condenser on the outdoor component gives off heat. Exposure to direct sunlight further increases the temperature of the fins and reduces the heat released by the finned heat exchanger. The outdoor component should be installed on to the north side of the building whenever possible. If necessary, take measures to provide sufficient shade (responsibility of customer). This can be accomplished with a small roof. However, the measures taken should not affect the flow of warm outlet air.

Wind

If the unit is being installed in windy areas, ensure that the warm outlet air discharges in the main wind direction. If this is not the case it may be necessary to install a windbreak (provided by the customer). Ensure that the windbreak does not adversely affect the air supply to the unit.

Windbreak

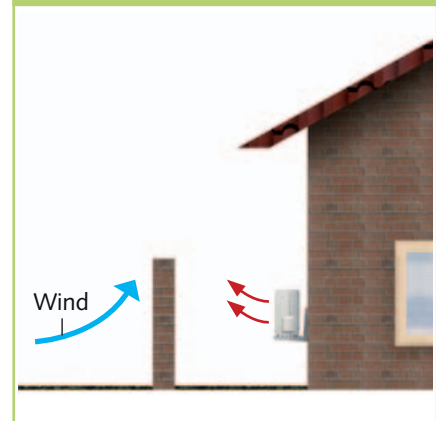

Snow

The unit should be wall-mounted in areas of heavy snowfall.

Installation should then be at least 20 cm above the expected level of snow to prevent snow from entering the outdoor component. An optional wall bracket is available as an accessory.

Minimum clearance to snow

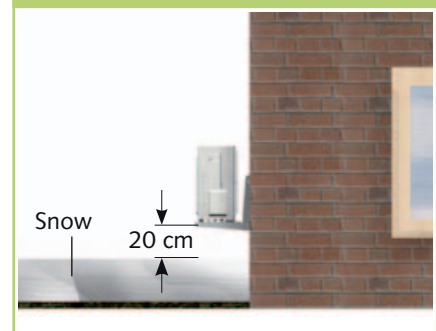

Installation inside buildings

- Ensure that heat can dissipate adequately when placing the outdoor component in cellars, attics, adjoining rooms or halls (**figure 4**).
- Install an additional fan with a rated flow comparative to that of the outdoor component being installed in the room. This is used in conjunction with ventilation ducts to compensate any pressure losses (**figure 4**).
- Ensure a continuous and unobstructed air flow from outside, preferably using sufficiently large air intakes placed opposite each other (**figure 4**).
- Comply with any regulations and conditions affecting the structure of the building. If necessary, fit acoustic installation.

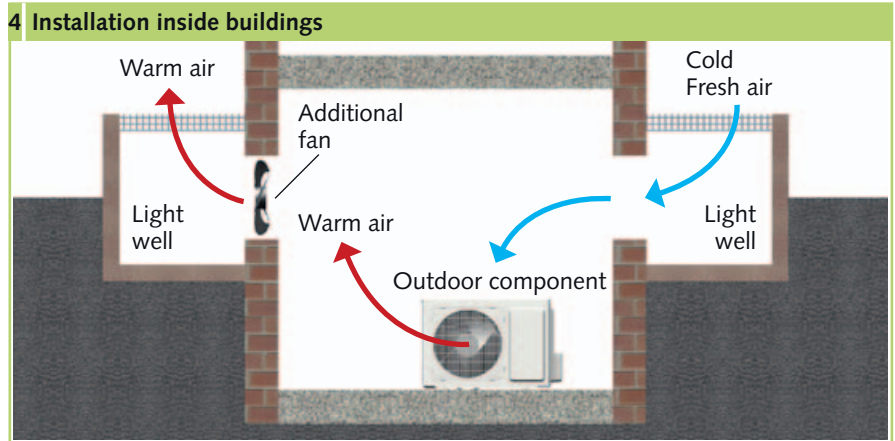

Minimum clearances

Observe the minimum clearances to allow access for maintenance and repair work and facilitate optimum air distribution.

	ML 226 DC AT ML 352 DC AT ML 522 DC AT
A	150 mm
B	700 mm
C	400 mm
D	150 mm
E	200 mm

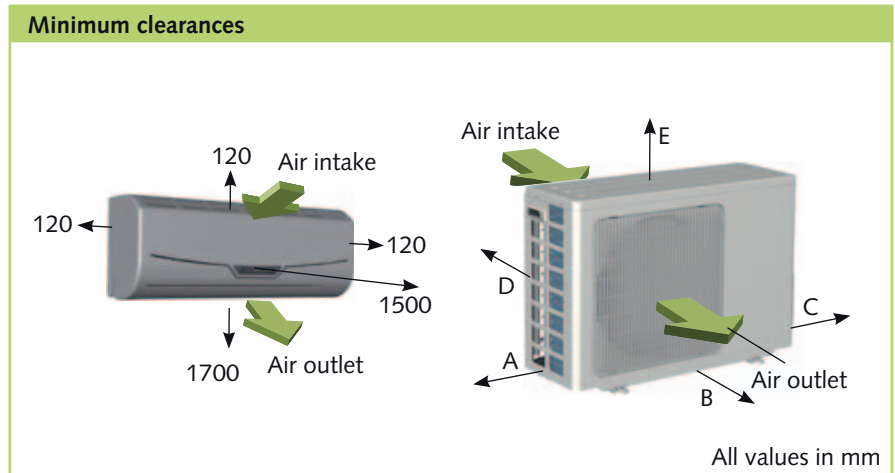

Mounting points for wall bracket

ML 226-352 DC IT

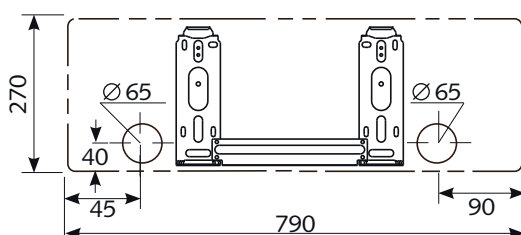

ML 522 DC IT

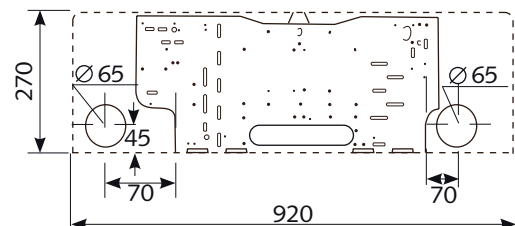

Oil return measures

If the outdoor component is installed at a higher level than the indoor unit, suitable oil return measures must be taken. This is normally accomplished by creating a bend in the oil line, installed at every 2.5 metres of rise.

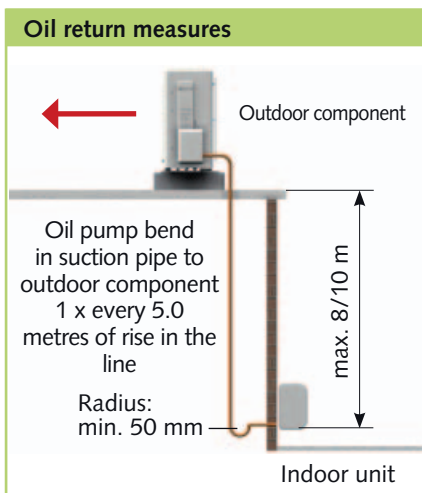

Connection variations of indoor unit

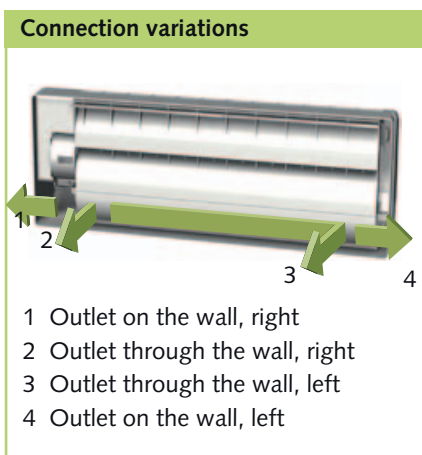

Wall bracket for indoor unit

The wall bracket for the unit must be attached with suitable screws and anchors.

Installation

NOTE

Installation may only be performed by authorised specialists.

Unit installation

The indoor unit is attached by means of a wall bracket, under consideration of air discharge side located in the lower part.

1. Mark the mounting points on the structurally permissible building sections according to the dimensions of the unit.
2. Remove the housing's break out opening if necessary.
3. Connect the refrigerant lines, electrical cables and condensation line to the indoor unit as described below.
4. Hang the indoor unit onto the wall bracket by tilting it back slightly and then by pressing the bottom part of the unit against the bracket (**figure 5**).
5. Check that the unit is level.

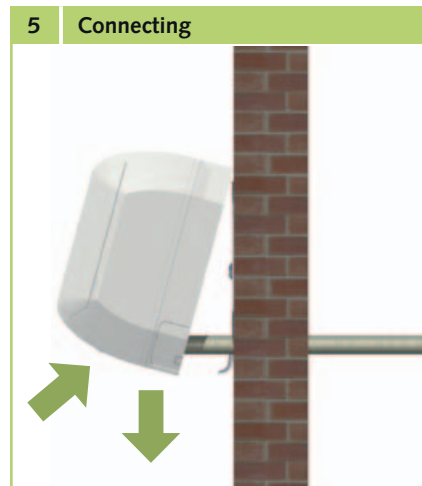

Connecting the refrigerant lines

The on-site connection of the refrigerant lines is carried out at the rear of the unit.

It may be necessary to fit a reducing or extending adapter to the indoor units. These fittings are included with the indoor unit as an accessory kit. Once installed, the connections should be sealed to prevent vapour diffusion.

ATTENTION

The units are factory filled with dry nitrogen to monitor for leaks. The pressurised nitrogen is released when the union nuts are loosened.

The following instructions describe the installation of the refrigerant circuit and the assembly of the indoor unit and the outdoor component.

1. The required pipe diameters are given in the table "Technical data".
2. Remove the factory-fitted protective caps and union nuts on the connections and use these during installation.
3. Before flanging the refrigerant lines, ensure that the union nut is on the pipe.
4. Prepare the refrigerant lines as shown below (**Page 19, figures 6+7**).

5. Verify that the shape of the flange is correct (figure 8).
6. First connect and hand-tighten the refrigerant connections to ensure they are correctly seated.
7. Now fully tighten the fittings using 2 suitably sized open-ended spanners. Use one spanner to counter the force when tightening the fitting (figure 9).
8. Use only diffusion-tight insulation hoses designed for this temperature range.
9. Lay the refrigerant lines from the indoor unit to the outdoor component. Ensure that they

are adequately fastened and take measures for the oil return, if necessary!

10. During installation, observe guidelines on the permitted bending radius for the refrigerant lines and never bend a line twice in the same place. Brittleness and cracking can result.

12. Ensure that structure-borne sound is not transferred to the building. Use vibration dampers to reduce the effects of structure-borne sound!
13. Prepare the refrigerant lines for the outdoor component as described above.

NOTE

Only use tools and components designed for refrigeration applications.

Supplementary information for Installation

- If the basic length of the refrigerant line exceeds 5 m, add refrigerant when commissioning the system for the first time. (See chapter "Add refrigerant").

11. Use the wall or floor brackets to fasten the outdoor component where structurally allowed (refer to the installation instructions for the brackets).

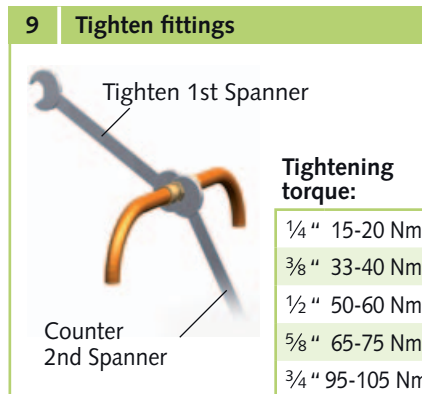
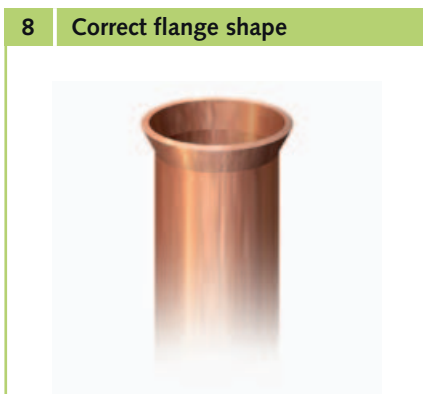
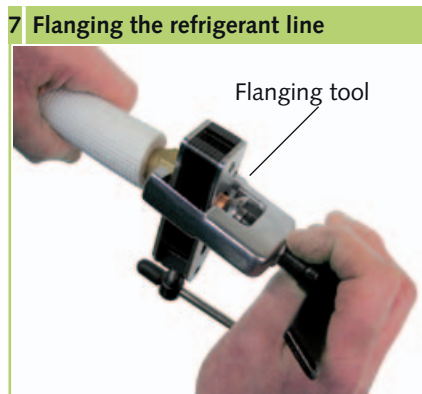
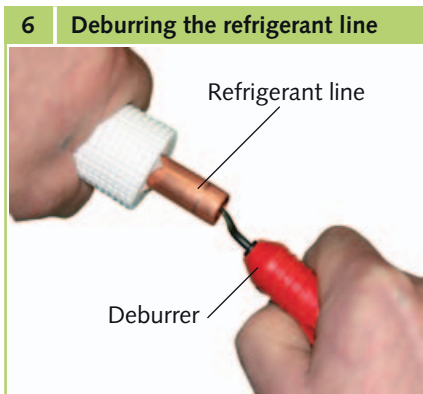

Monitoring for leaks

Once all the connections have been established, the pressure gauge station is attached as follows to the Schrader valve (if fitted):

- red = small valve
= injection pressure
- blue = large valve
= suction pressure

Once connected, perform a leak test using dry nitrogen.

The tightness test involves spraying a leak detection spray onto the connections. If bubbles are visible, the connections have not been properly made. Tighten the connection or prepare a new flange.

If the leak test is successful, depressurise the refrigerant lines and start a vacuum pump with an absolute final partial pressure of min. 10 mbar to create a vacuum in the lines. Any moisture present in the pipes will also be removed.

ATTENTION

A vacuum of min. 20 mbar must be created!

The time required to generate the vacuum is dependent on the pipework volume of the indoor unit and the length of the refrigerant lines. The process will always take at least **60 minutes**.

Once any foreign gases and moisture have been completely extracted from the system, the valves on the pressure gauge station will be closed and the valves on the outdoor component will be opened as described in the chapter on "Commissioning".

Condensate connection

Due to undercutting of the dew point at the vaporiser, condensation forms during **cooling** and in the condenser during **heating**.

Below the vaporiser is a collection tray, which must be connected to a drain.

The lower section of the outdoor component's housing is designed to serve as a collection tray. The condensate connection included in the scope of delivery is to be attached here.

- The condensate line is to be installed with a minimum slope of 2 %. (**figure 10**). If necessary, fit vapour diffusion tight insulation.
- Lead the condensate line freely to the run-off line. If the condensate runs directly into a sewer pipe, fit a trap to prevent any unpleasant odours.
- When operating the unit at outdoor temperatures below +4 °C, make sure to route the condensation to prevent freezing. The lower part of the housing is also to be kept frost free by the user, in order to ensure permanent draining of the condensate. If necessary, fit supplementary pipe heating.
- After completed installation, check for unobstructed condensation run off and ensure that a permanent seal is provided.

10 Slope of the condensation line

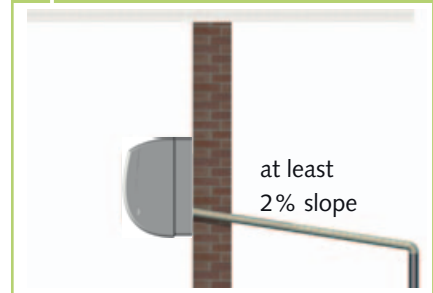

The condensate hose is designed to be installed on the left side (viewed from the front).

Electrical connection

A mains cable must be installed as voltage supply to the outdoor component and a control cable to the indoor unit, with appropriate safeguards.

ATTENTION

All electrical installation work is to be performed by specialty companies. Disconnect the voltage supply when connecting the electrical terminals.

- We recommend that a mains/repair switch be installed near the outdoor component.
- If an optionally available condensation pump is used on the unit, then an additional relay for the shut-off contact of the pump will be needed to increase the switching power to shut off the compressor.
- Control cables should be screened if laid in areas exposed to strong magnetic fields.
- Electrical protection is provided in accordance with the technical data.

Connecting the indoor unit

Make the connection as follows:

1. Open the air intake grill.
2. Loosen the cover to the terminal strip on the right side. **(figure 11).**
3. Connect the unit to the control cable from the outdoor component. See electrical connection diagram.
4. Re-assemble the unit.

Connecting the outdoor component

Proceed as follows to connect the cable:

1. Remove the plastic panel at the connector.
2. Select the cable cross-section according to the relevant standards.
3. Feed both cables through the edge protection rings on the fixed connection panel.
4. Connect the cables as shown on the electrical connection diagram.

5. Anchor the cable in the strain relief and re-assemble the unit. **(figure 12).**

⚠ ATTENTION

Check all plugged and clamped terminals to verify they are seated correctly and make a permanent contact. Tighten as required.

11 Connecting the indoor unit

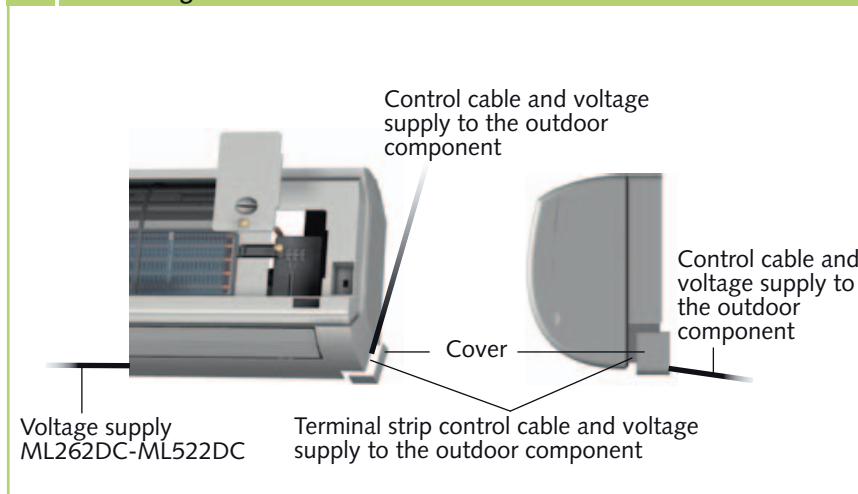

12 Connecting the outdoor component

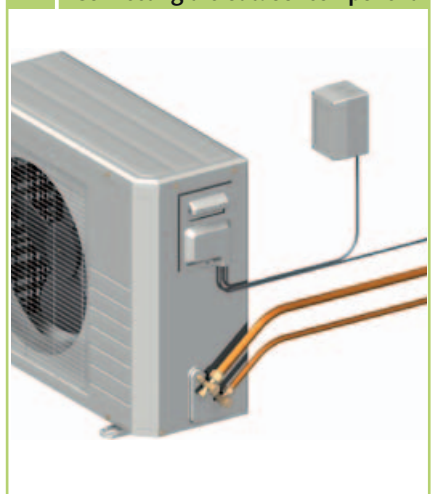

Electrical connection diagram

Connection ML 262 DC to ML 522 DC

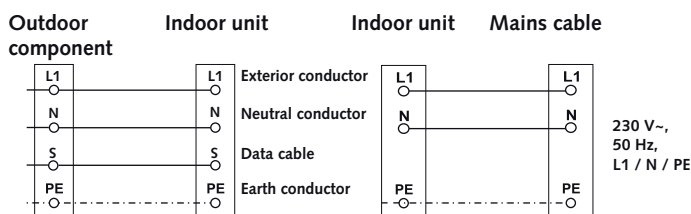

REMKO ML...DC

Electrical circuit diagram

ML 262-352 DC AT

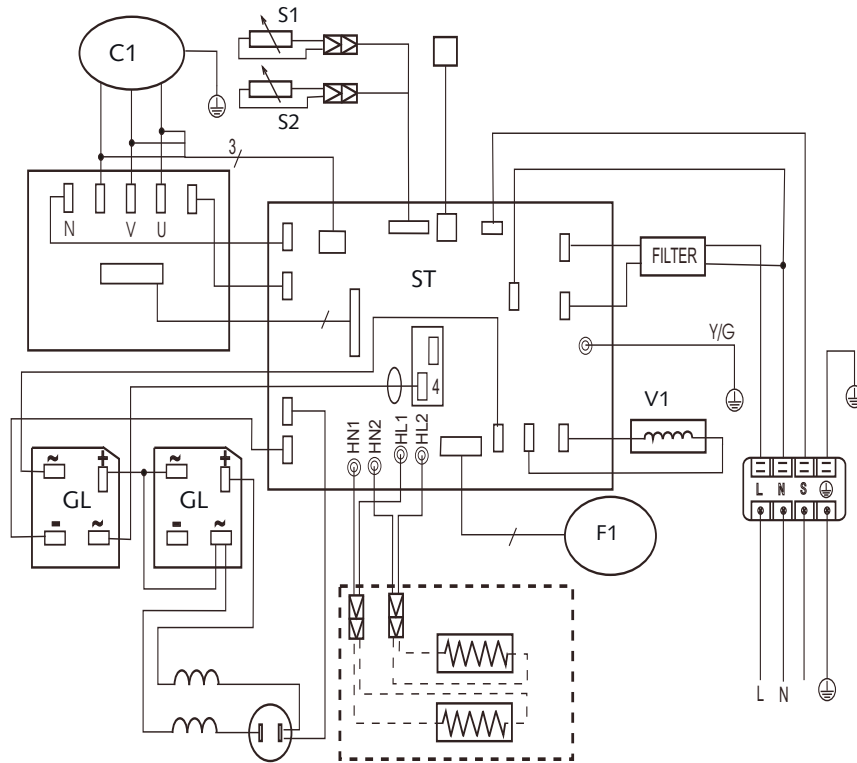

- C1 = Compressor
- S1 = Condenser feeler
- S2 = Air-intake sensor
- S3 = Heated gas sensor
- S4 = Compressor sensor (Klixon)
- V1 = Reverse flow valve
- F1 = Condenser fan
- LP = Power board
- ST = Control board
- GL = Rectifier

ML 522 DC AT

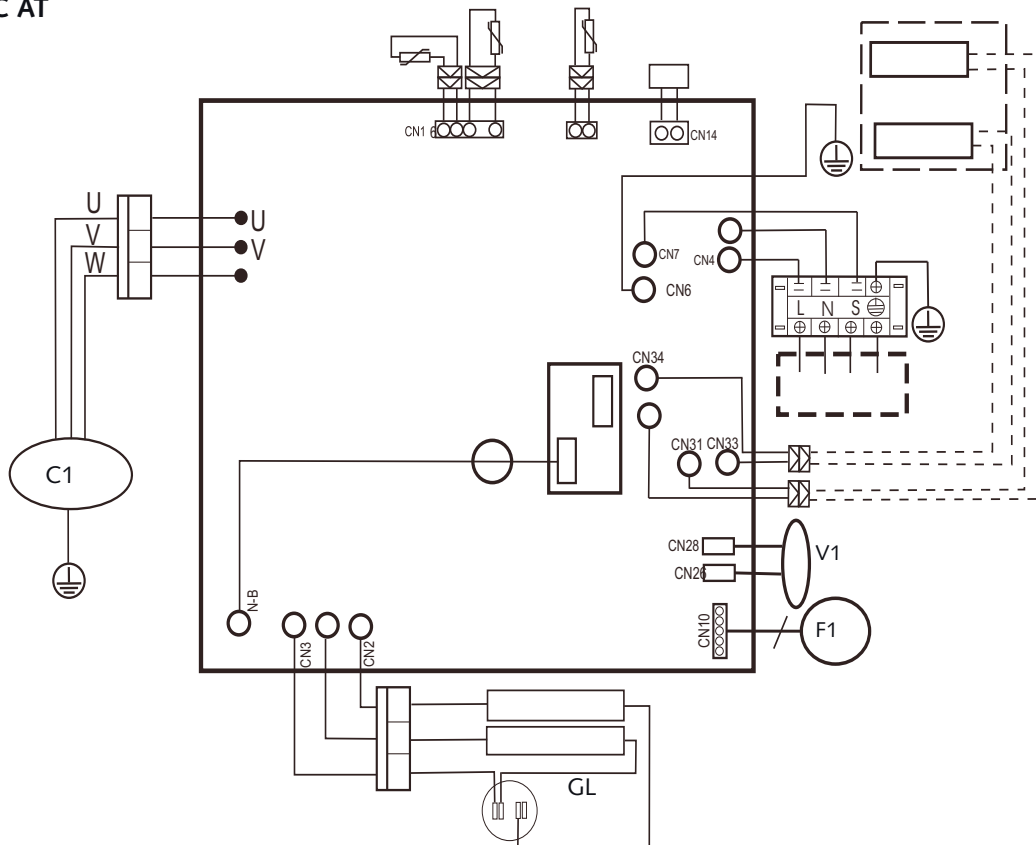

Electrical circuit diagram

ML 262-522 DC IT

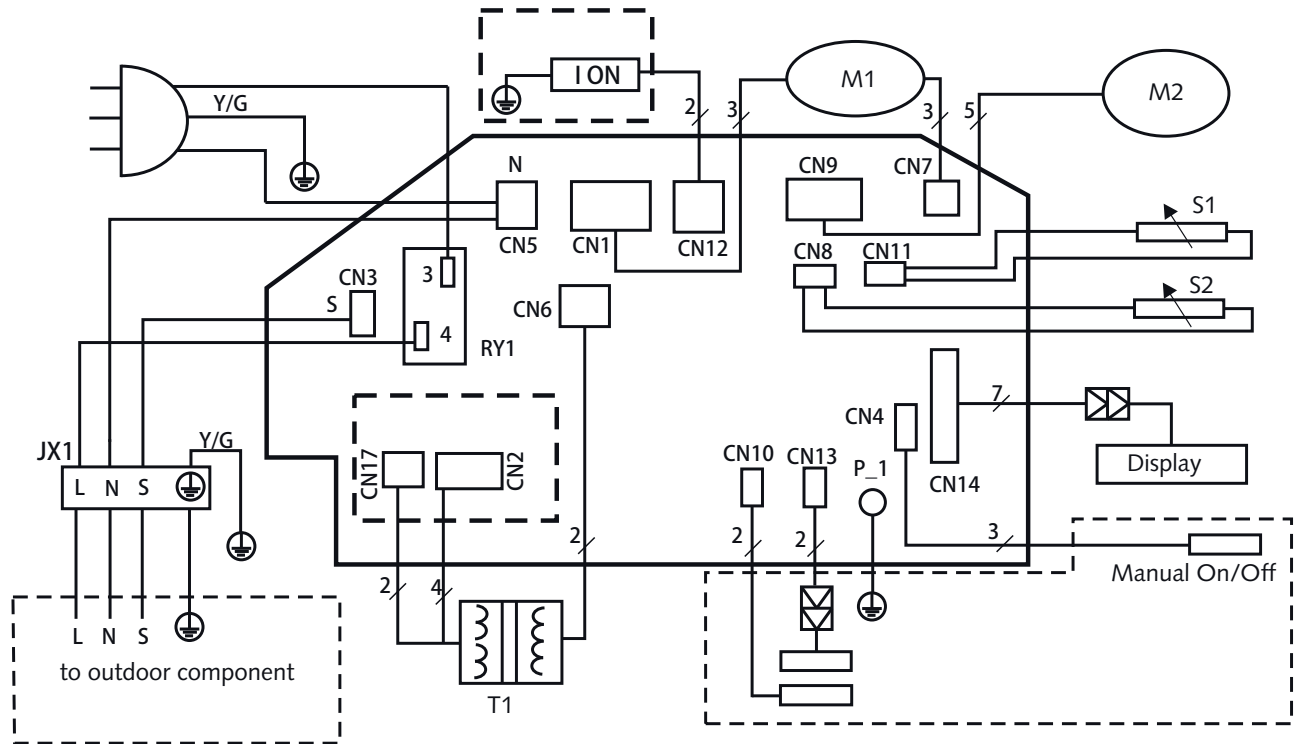

- M1 = Swing motor
- M2 = Fan motor
- T1 = Transformer
- S1 = Air circulation sensor
- S2 = Vaporiser sensor
- V1 = Board display
- F1 = Manual On/Off

Before Commissioning

After the tightness check has been successfully completed, connect the vacuum pump via the pressure gauge station to the valve connections on the outdoor component (see chapter "Tightness check") and create a vacuum.

Perform the following checks prior to putting the unit into operation for the first time and after any work on the refrigeration circuit. Record the results in the commissioning report:

- Check all refrigerant lines and valves using leak detection spray or soapy water for leaks and for inadvertent reversal of the suction and injection lines, with the unit at a standstill.
- Check refrigerant lines and insulation for damage.
- Check electrical connection between indoor unit and outdoor component for correct polarity.
- Check that all fastenings, mountings etc. are firm and at the correct level.

ATTENTION

Make sure that the refrigerant which is used is always filled in liquid form!

NOTE

Check the refrigerant fill quantity in the event of overheating

Add refrigerant

ATTENTION

Wear protective clothing when handling refrigerant.

The equipment contains a basic quantity of refrigerant. Furthermore, for refrigerant line lengths of more than 5 metres per circuit, an additional amount of refrigerant must be added, in accordance with the following chart:

	ML 262	ML 352	ML 522
Basic line length	Additional fill quantity		
Up to and incl. 5 m	0 g/m		
5 m to max. 20 m	30 g/m	30 g/m	30 g/m

Commissioning

NOTE

Commissioning is only to be performed and documented by specially trained personnel.

Once all the components have been connected and tested, the system can be commissioned. A functional check should be performed to verify its correct function and identify any unusual operational behaviour prior to handing it over to the operator.

NOTE

Check that the stop valves and valve caps are tight after carrying out any work on the refrigerant circuit. Use appropriate sealant products as necessary.

Function test and test run

Check the following points:

- Leak tightness of refrigerant lines.
- Compressor and fan running smoothly.
- In cooling mode, cold air output by the indoor unit, and warm air output by the outdoor component.
- Functional test of the indoor unit and all program sequences.
- Check of the surface temperature of the suction pipe and determination of vaporiser overheating. To measure the temperature, hold the thermometer to the suction pipe and subtract the boiling point temperature reading on the pressure gauge from the measured temperature.
- Documentation of the measured temperatures in the commissioning report.

Functional test for the cooling and heating modes

1. Remove the caps from the valves.
2. Begin the commissioning process by briefly opening the shut-off valves of the external unit until the manometer displays a pressure of approx. 2 bar.
3. Use leak detection spray or suitable devices to check that all the connections are leak tight.

4. If no leaks are found, open the stop valves by turning them anti-clockwise as far as they will turn using a hexagon spanner. If leaks are found, repair the faulty connection. It is imperative that the vacuum creation and drying steps are repeated!
5. Switch on the mains switch or circuit breaker.
6. Use the remote control to switch on the unit and select the cooling mode, maximum fan speed and lowest target temperature.
7. Measure and record all the required values in the commissioning report and check the safety functions.
8. Check the unit's control element using the functions described in the chapter "Operation".
9. Check the correct function of the condensation line by pouring distilled water into the condensation tray. A bottle with a spout is recommended for pouring the water into the condensation tray.
10. Switch the indoor unit to cooling mode.
11. Check the correct function and settings of all control and safety devices during the test run.
12. Check the control system in the indoor unit using the functions described in the operating manual. Timer, temperature settings and all mode settings.
13. Check the overheating, outdoor, indoor, outlet and vaporisation temperatures and record the measured values in the commissioning report.
14. Switch the indoor unit to heating mode.
15. Check all the previously described safety devices and functions during the test run.
16. Enter the measured data in the commissioning report.
17. Remove the pressure gauge. Check that seals have been fitted in the sealing caps.

Final tasks

- Reassemble all disassembled parts.
- Familiarise the operator with the system.

Unit dimensions

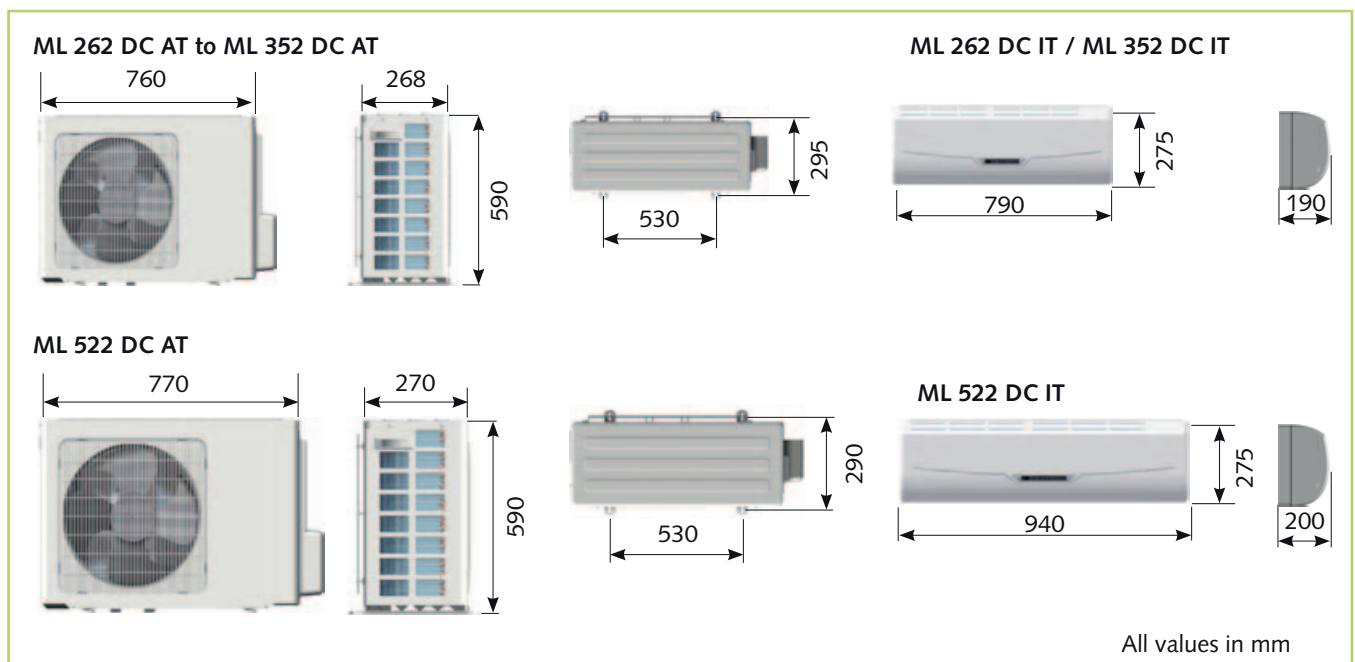

We reserve the right to modify the dimensions and constructional design as part of the ongoing technical development process.

REMKO ML...DC

Exploded view ML 262 DC IT to ML 522 DC IT

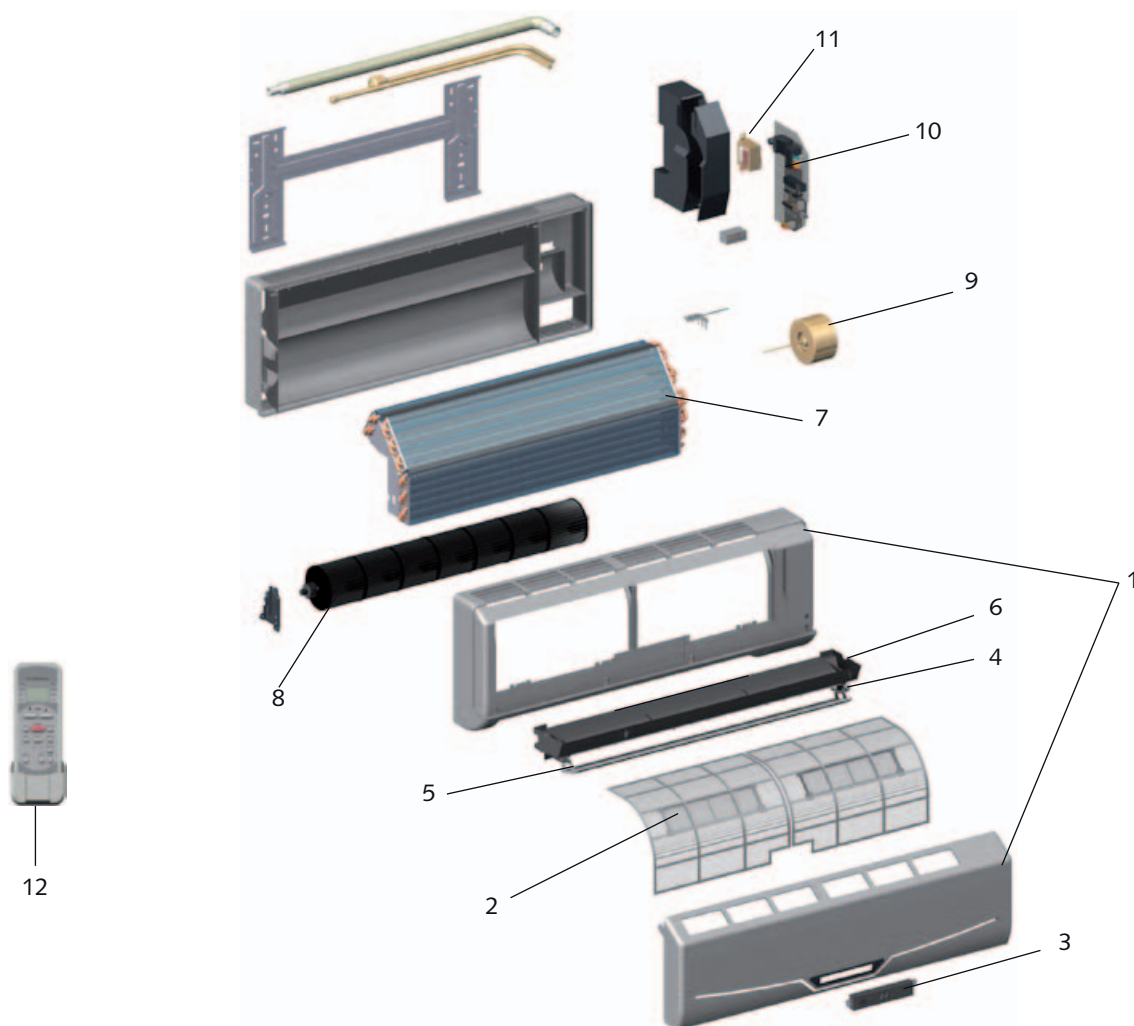

We reserve the right to modify the dimensions and constructional design as part of the ongoing technical development process.

Spare parts list

No.	Designation	ML 262 DC IT	ML 352 DC IT	ML 522 DC IT
	From Serial number	802W6001...	808W6001...	809W6001...
1	Complete front panel	1111150	1111150	1111151
2	Air filter, set	1111152	1111152	1111153
3	Board, display	1111180	1111182	1111183
4	Swing motor	1111156	1111156	1111156
5	Air outlet fins, set	1111157	1111157	1111158
6	Condensation tray	1111159	1111159	1111160
7	Vaporiser	1111161	1111162	1111163
8	Fan wheel	1111164	1111164	1111165
9	Fan motor	1111166	1111166	1111167
10	Control board	1111168	1111169	1111170
11	Transformer	1111171	1111171	1111172
12	IR remote control	1111181	1111181	1111181
Spare parts (not illustrated)				
	Air circulation sensor	1111216	1111174	1111174
	Vaporiser sensor	1111179	1111175	1111175

When ordering spare parts, please state the computerised part no., device unit number and type of device (see identification plate)!

Exploded view ML 262 DC AT to ML 522 DC AT

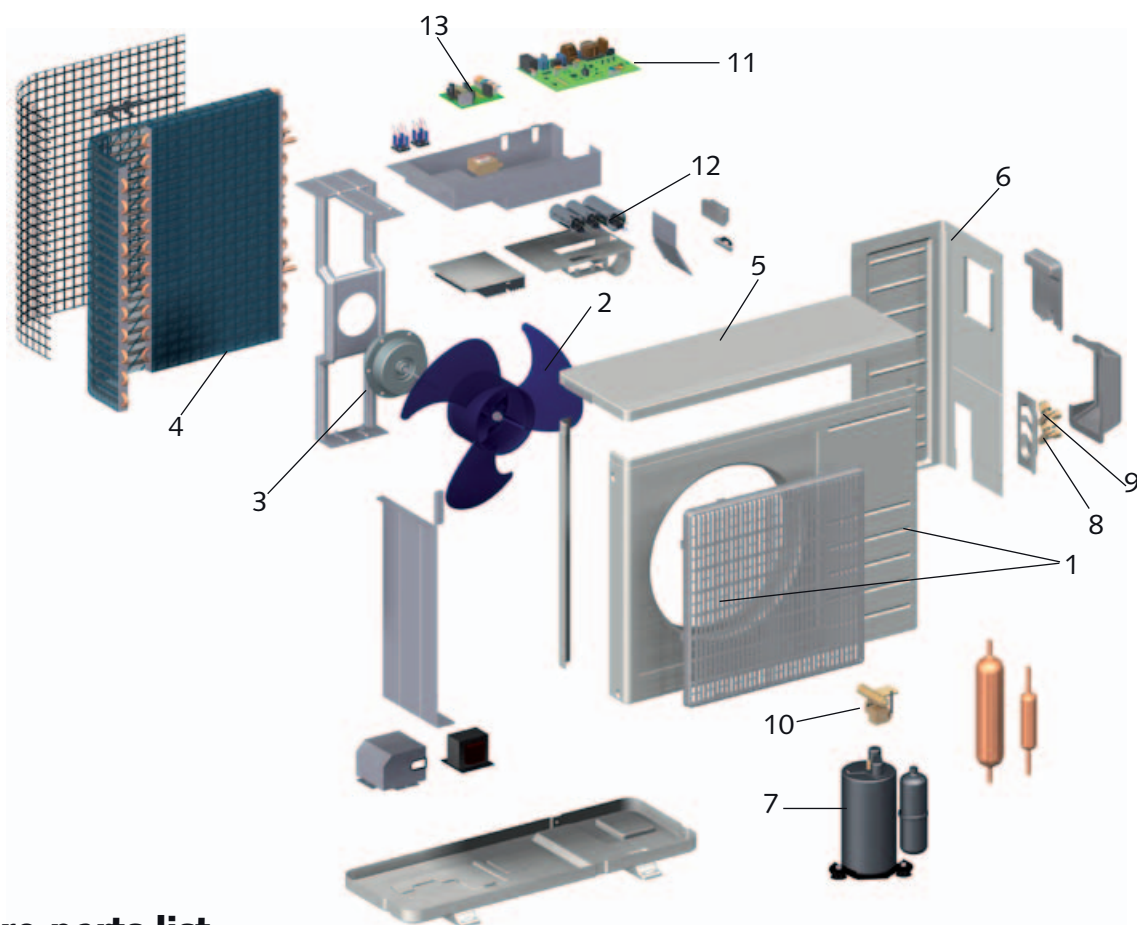

Spare parts list

No.	Designation	ML 262 DC AT	ML 352 DC AT	ML 522 DC AT
	From Serial number	802W9001...	808W9001...	809W9001...
1	Front panel	1111190	1111230	1111231
2	Fan blade, condenser	1111193	1111232	1111233
3	Fan motor, condenser	1111195	1111234	1111235
4	Condenser	1111197	1111236	1111237
5	Cover panel	1111200	1111238	1111239
6	Side panel	1111203	1111240	1111241
7	Compressor, cpl.	1111204	1111242	1111243
8	Stop valve, suction line	1111206	1111244	1111245
9	Stop valve, injection line	1111207	1111246	1111247
10	Reverse flow valve	1111208	1111248	1111249
11	Control board	1111210	1111250	1111251
12	Condenser, compressor	1111213	1111252	1111253
13	IPM inverter power drive	1111214	-	-
Spare parts (not illustrated)				
	E-Box, complete	1111216	1111254	1111218
	Temperature sensors, set	1111219	1111255	1111219
	Electrical heater cable	1111256	1111256	1111256

When ordering spare parts, please state the computerised part no., device number and type of device (see identification plate)!

Performance data ML 262 DC

Cooling

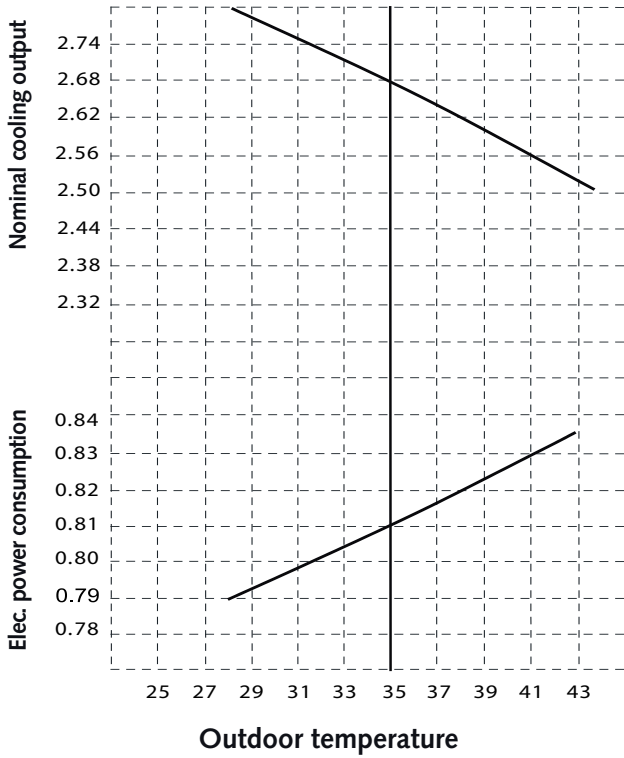

Heating

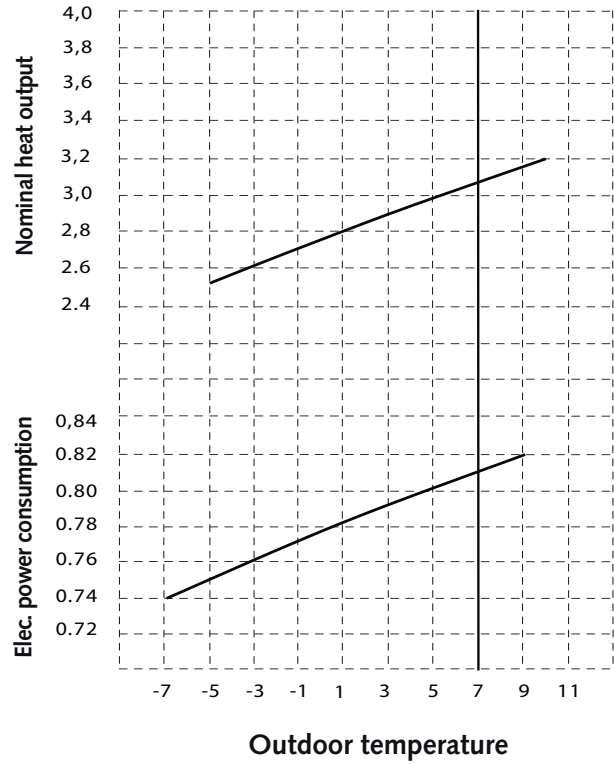

Performance data ML 352 DC

Cooling

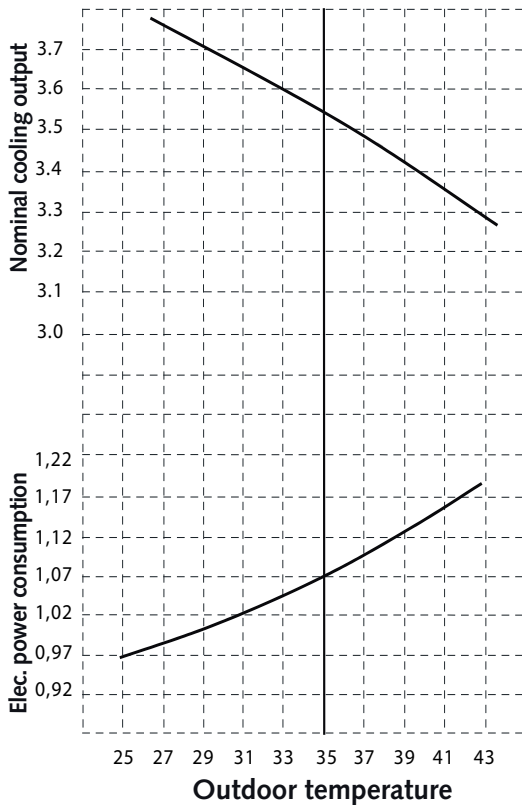

Heating

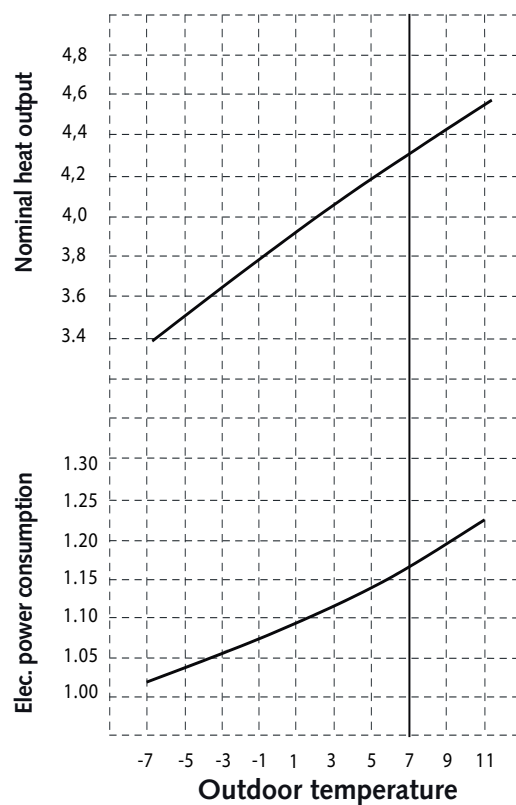

Performance data ML 522 DC

Cooling

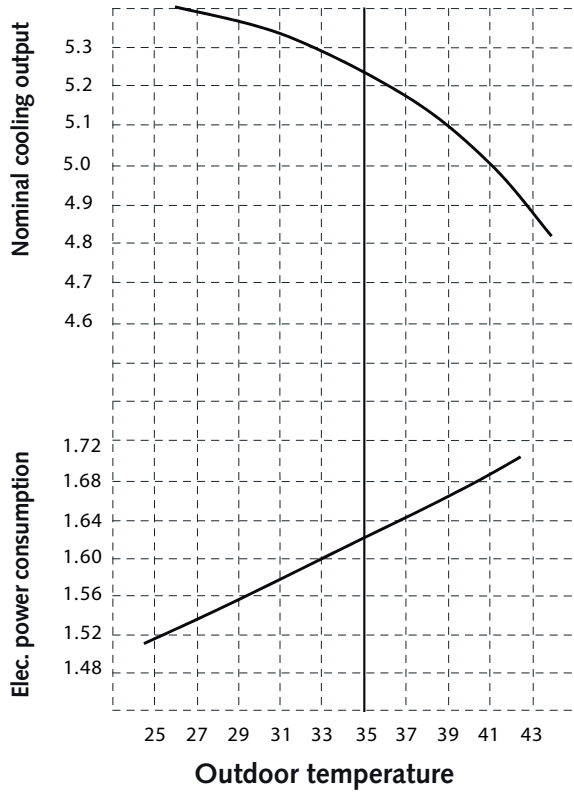

Heating

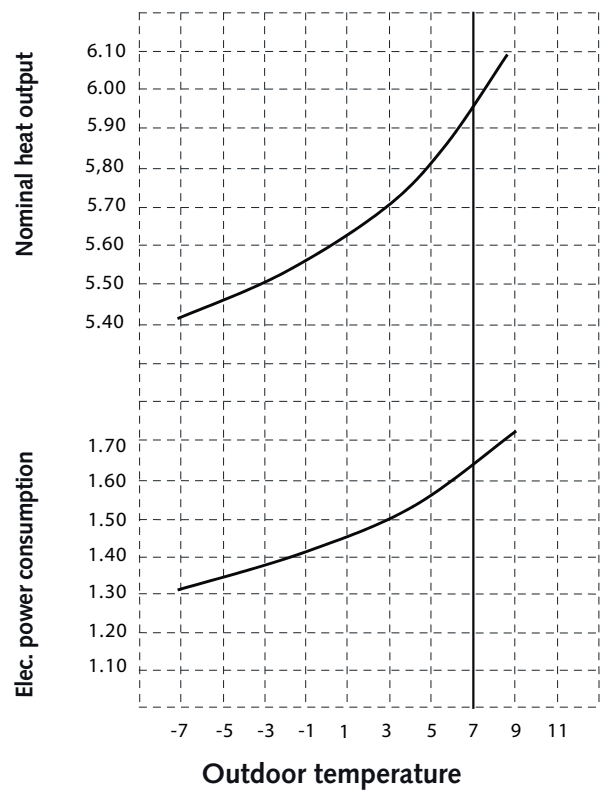

Technical data

Series		ML 262 DC	ML 352 DC	ML 522 DC
Operational mode		Wall / room air conditioner combination for cooling and heating		
Nominal cooling output ¹⁾	kW	2,68 (0,67-3,52)	3,52 (0,72-3,96)	5,24 (1,49-6,45)
Nominal heating output ²⁾	kW	3,15 (0,70-3,75)	4,29 (0,82-4,69)	5,94 (1,55-6,74)
Energy efficiency class, cooling ¹⁾		A	A	A
Energy efficiency ratio EER ¹⁾		3,31	3,29	3,23
Energy efficiency class, heating ²⁾		A	A	A
Coefficient of performance COP ²⁾		3,71	3,67	3,61
Power consumption, annual, (500h) K / H		405 / 400	555 / 580	845 / 960
Operating range (room volume), approx.	m ³	80	110	160
Refrigerant		R 410A ⁴⁾		
Power supply	V/Hz	230 / 1~ / 50		
Nom. electrical power consumption, cooling ¹⁾	kW	0,81 (0,19-1,18)	1,07 (0,21-1,38)	1,62 (0,38-2,32)
Nom. electrical power consumption, heating ²⁾	kW	0,81 (0,19-1,10)	1,17 (0,21-1,18)	1,64 (0,35-2,05)
Elec. nominal power consumption cooling ¹⁾	A	3,70 (0,9-5,2)	4,40 (1,0-6,2)	7,09 (1,8-10,2)
Elec. nominal power consumption heating ²⁾	A	3,60 (0,9-5,0)	4,5 (1,0-6,6)	7,25 (1,6-9,2)
Elec. starting current, max.	A	8	10	10
Refrigerant connection - injection line	Inches (mm)	1/4 (6,35)	1/4 (6,35)	1/4 (6,35)
Coolant connection - suction line	Inches (mm)	3/8 (9,52)	1/2 (12,70)	1/2 (12,70)
Max. operating pressure	kPa	4200 / 4200		
Corresponding indoor unit		ML 262 DC IT	ML 352 DC IT	ML 522 DC IT
Adjustment range, room temperature	°C	+17 to +30		
Operating range	°C	+16 to +31		
Air flow volume per speed setting	m ³ /h	500/420/350	550/450/370	800/700/600
Sound pressure level per speed setting ³⁾	dB(A)	29/34/39	31/37/40	37/39/42
Protection class	IP	X0		
Condensate connection	mm	14	14	14
Dimensions - height	mm	275	275	275
Width	mm	790	790	940
Depth	mm	190	190	200
Weight	kg	8,5	8,5	11,0
Corresponding outdoor component		ML 262 DC AT	ML 352 DC AT	ML 522 DC AT
Operating range - cooling	°C	+5 to +50		
Operating range - heating	°C	-7 to +25		
Air flow rate, max.	m ³ /h	1700	1850	1500/2200
Protection class	IP	24		
Sound pressure level, max. ³⁾	dB(A)	50	51	54
Refrigerant, basic quantity	kg	0,83	0,94	1,10
Refrigerant, additional quantity > 5 m	g/m	30	30	30
Refrigerant line, max. length	m	20	20	25
Refrigerant line, max. height	m	8	8	10
Dimensions - height	mm	590	590	590
Width	mm	760	760	760
Depth	mm	270	270	270
Weight	kg	38,0	39,0	39,5
Serial number		1632262	1632352	1632522
EDP no.		802...	808...	809...

1) Air inlet temperature TK 27°C / FK 19°C, outdoor temperature TK 35 °C, FK 24 °C, max. air flow volume, 5m line length

2) Air inlet temperature TK 20°C, outdoor temperature TK 7°C, FK 6°C, max. air flow volume, 5m line length

3) Distance 1 m free field

4) Contains greenhouse gas according to Kyoto protocol

EC – Declaration of Conformity

in accordance with the Machinery Directive, Annex II 1A

Original Declaration of Conformity



We hereby declare that the devices described in the following section conform to the requirements of the specified applicable EC directives due to their design and type in the version as marketed by us.

Name of Manufacturer: REMKO GmbH & Co. KG
Klima- und Wärmetechnik
Im Seelenkamp 12
D - 32791 Lage

Name of Authorised Agent: REMKO GmbH & Co. KG
Klima- und Wärmetechnik
Im Seelenkamp 12
D - 32791 Lage

Equipment (machinery) - Implementation: Inverter wall mounted units in split design
and frost protection function

Series / Model: REMKO ML 262DC, ML 352DC, ML 522DC

Series / Class Number: 802..., 808..., 809

Applicable regulations:

MA DIR. 2006/42/EC	Machinery Directive
LV DIR. 2006/95/EC	Low-Voltage Directive
EMC DIR. 2004/108 EEC	Electromagnetic Compatibility Directive
EnCLB DIR. 92/75/EEC	Energy Consumption Labelling Directive
EC 97/23/EC	Pressure Equipment Directive

Applicable Standards:

DIN EN ISO 12100-1-2 :2004-04; DIN EN ISO 13857,
EN 14511 T1-4;
DIN 45635 - 1;
EN 378 – 1-4;
EN 55014 - 1; EN 55014 - 2; EN 55104
EN 60204 - 1; EN 60335 - 1; EN 60335 - 2 - 40;
EN 61000 - 3 - 2; EN 61000 - 3 - 3;

Lage, 22nd January 2010

REMKO GmbH & Co. KG

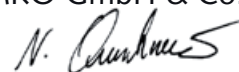
A handwritten signature in black ink, appearing to read 'N. ...'.

.....
Signature, Product Manager

REMKO INTERNATIONAL

*... and also right in your neighbourhood!
Make use of our experience and advice*



REMKO GmbH & Co. KG **Air conditioning and heating technology**

Im Seelenkamp 12
Postfach 1827
Telephone
Telefax
E-mail
Website

D-32791 Lage
D-32777 Lage
+49 5232 606-0
+49 5232 606-260
info@remko.de
www.remko.de

Hotline
+49 5232 606-0

Export
+49 5232 606-130

Consultation

Thanks to intensive training, our consultants are always completely up-to-date in terms of technical knowledge. This has given us the reputation of being more than just an excellent, reliable supplier: REMKO, a partner helping you find solutions to your problems.

Distribution

REMKO offers not just a well established sales network both nationally and internationally, but also has exceptionally highly qualified sales specialists. REMKO field staff are more than just sales representatives: above all, they must act as advisers to our customers in air conditioning and heating technology.

Customer service

Our equipment operates precisely and reliably. However, in the event of a fault, REMKO customer service is quickly on the scene. Our comprehensive network of experienced dealers always guarantees quick and reliable service.

