

REMKO CONDENSATE CATCH TRAY WITH INTEGRATED OIL SEPARATOR

Installation and Operating Manual

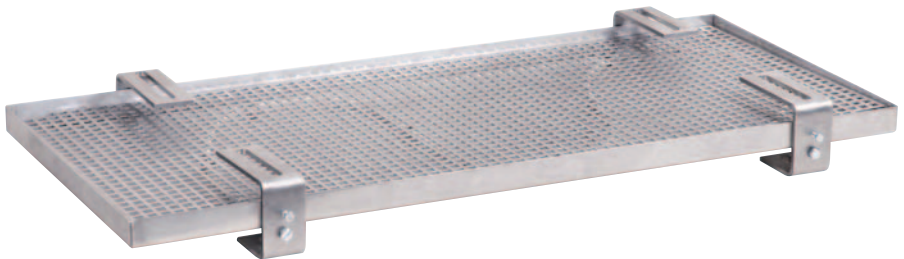

Contents

<i>Safety notes</i>	4
<i>Environmental protection and recycling</i>	5
<i>Warranty</i>	5
<i>Intended use</i>	5
<i>Description</i>	5-6
<i>Installation - wall-mounted console - CMF/CMT 120</i>	6-8
<i>Installation - wall-mounted console - CMF/CMT 160</i>	9-12
<i>Installation - floor console -</i>	13-15
<i>Draining water produced from defrosting or condensation.</i>	16
<i>Electrical connection</i>	17
<i>Earthing of the condensation catch tray</i>	18
<i>Maintenance and Cleaning</i>	19
<i>Technical data</i>	19

**Read these operating instructions carefully
before commissioning / using these units!**



**These instructions are an integral part of the unit and must
always be kept in the vicinity of the installation location or
on the unit itself.**

This operating manual is a translation of the German original.

*Subject to modifications; no liability accepted for errors or
misprints!*

REMKO CONDENSATE CATCH TRAY WITH INTEGRATED OIL SEPARATOR

Safety notes

Carefully read the operating manual before placing the unit into service for the first time. It contains useful tips and  notes such as  hazard warnings to prevent injury and material damage. Failure to follow the directions in this manual can result in endangerment to persons, the environment and the equipment itself and will void any claims for liability.

- Keep this manual in the vicinity of the units.
- The units and components may only be set up and installed only by qualified personnel.
- The set-up, connection, and operation of the units and components must be in accordance with the operating conditions stipulated in this manual and comply with all applicable local regulations.
- The condensate catch tray must be grounded.
- Modification of units and components supplied by REMKO is not permitted and can cause malfunctions.
- Units and components may not be operated in areas where there is an increased risk of damage. Observe the minimum clearances.
- The electrical power supply is to be adapted to the requirements of the units.
- The operational safety of units and components is only assured if they are fully assembled and used as intended. Safety devices may not be modified or bypassed.
- Do not operate units or components with obvious defects or signs of damage.
- The units and components must be kept at a safe distance from flammable, explosive, combustible, aggressive and dirty areas or atmospheres.
- Installation, repair and maintenance work may be carried out only by authorised specialists. Visual inspections and cleaning can be performed by the operator as long as power is disconnected from the equipment.
- To preclude any danger to persons from the unit, take appropriate precautions when performing installation, repair or maintenance work or cleaning the units.

Environmental protection and recycling

Disposing of packaging

All products are packed for transport in environmentally friendly materials. You can make a valuable contribution to reducing waste and sustaining raw materials by only disposing of packaging at approved collection points.



Disposing of the components

The manufacturing process for the units is subject to continuous quality control. Only high-grade materials are used, the majority of which are recyclable. You can also contribute to environmental protection by only disposing of components in accordance with local regulations and in an environmentally safe manner, e.g. through authorised disposal and recycling specialists or at collection points.

Warranty

The warranty conditions are listed in the "General terms and conditions". Please contact your direct contract partner first.

Intended use

The condensate catch tray accessory catches condensation or water produced from defrosting under the air conditioning unit from which it can be drained in a controlled manner. Another or additional use is considered an unintended use. The manufacturer/supplier assumes no liability for damages arising from such use. The user bears the sole risk in such cases.

Intended use also includes working in accordance with the operating manual and installation instructions and complying with the maintenance requirements.

Description

The condensate catch tray catches condensation or water produced from defrosting under the unit from which it can be drained in a controlled manner. This keeps the installation site dry, which can be a structural requirement, and also reliably prevents ice from forming below the unit. The condensate can be drained using an existing drain pipe or by installing a trickle line insofar as the soil can absorb the seepage. The condensate catch tray comprises a stainless steel tray, a leaf grill, a condensate drain heater, brackets and miscellaneous fastening material.

REMKO CONDENSATE CATCH TRAY WITH INTEGRATED OIL SEPARATOR

Local regulations or environmental laws, for example the German Water Resource Act (WHG), can require that suitable precautions be taken to protect against uncontrolled drainage in case of leakage to provide for safe disposal of escaping air conditioning fluid or hazardous media.

The oil protector with integrated oil separator, for the fluids WGK1- GK3, prevents any oil that might be in the oil tray from being rinsed out by rainfall. The oil is held back completely and kept from running out. Condenser sets installed on the oil tray will not result in water contamination in the event of leaks.

Installation in connection with wall-mounted consoles

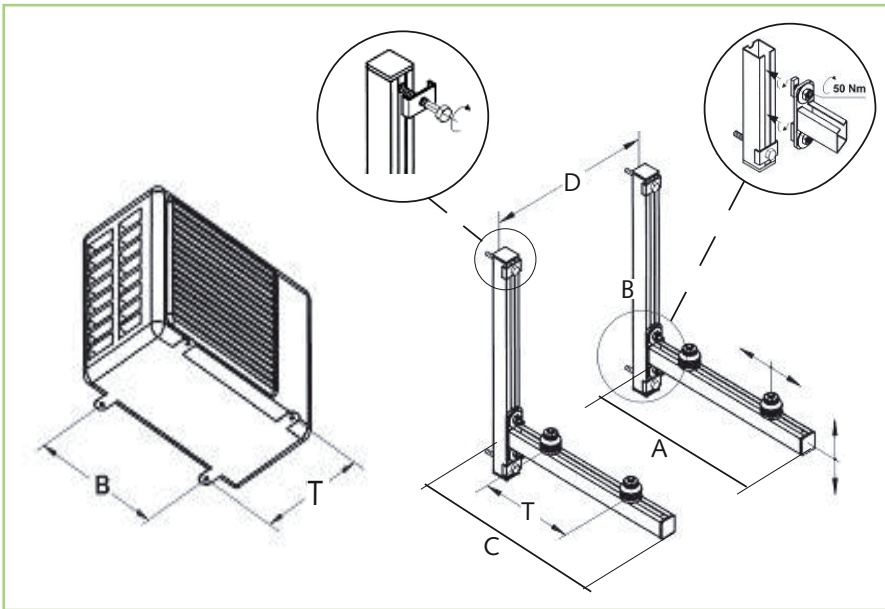

NOTE

Select the fastening material suitable for the wall to which the condensate catch tray is to be fastened!

Install the wall-mounted console to the building only where structurally permitted.

Make sure when drilling to place anchors that there are no supply lines where you are drilling.

The wall-mounted console must be fastened so that it can carry the weight of the unit. Make sure that no vibrations are transferred to the masonry. If necessary, install insulation (see accessory programme).

Refrigerant lines and electrical lines must be installed from the rear or from the right, not from below!

Install the outdoor unit on the wall-mounted console as follows:

1. Using suitable fastening material, install the unit on a wall designed to carry the load. Make sure that the height at which it is installed above the floor is adequate (above the expected snow level!) and that the clearance of the wall-mounted consoles on the left and on the right is adequate for the type of unit being installed (clearance B). It is best to take the clearance B directly from the outdoor component. The brackets with the vibration dampers included in the scope of delivery are placed on the two supports as shown in the illustration. First tighten the bolts lightly by hand so that the bracket clearances can be easily adjusted.

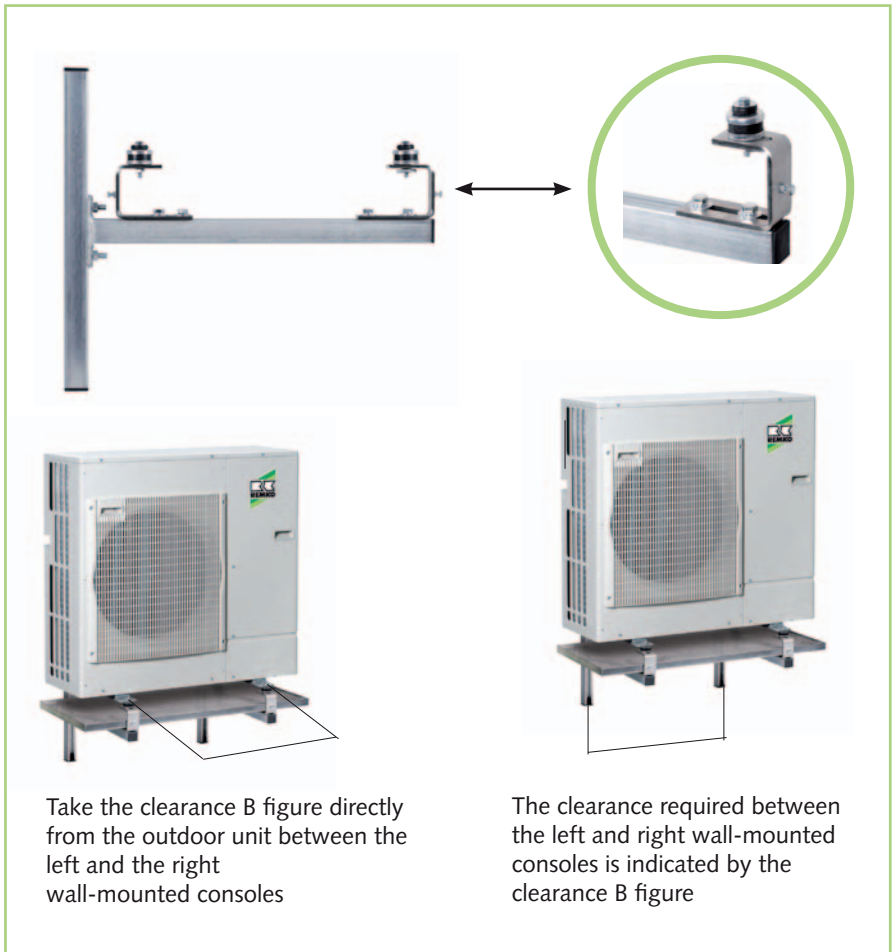

REMKO CONDENSATE CATCH TRAY WITH INTEGRATED OIL SEPARATOR

2. Now push the condensate catch tray from the left or from the right between the preinstalled brackets



3. Set the outdoor unit on the preinstalled vibration dampers and pull them to the correct distance on the aligned brackets and tightly tighten all other bolts. Secure the outdoor unit with the 4 (M6 x 50) bolts included in the scope of delivery



Delivery of the wall-mounted console (WKM 560)

Pos.	Description	Quantity
1	Wall bar	2
2	Bracket	2
3	Vibrations dampers with nuts	4
4	Sheet steel angle	4
5	T-head screws	4



NOTE

The vibration dampers are included in the standard scope of delivery for the wall-mounted consoles.

Installation in connection with wall-mounted consoles for CMF/CMT 160 (Type WKM 560 Plus)

Distance of the mounting feet
(outdoor unit)

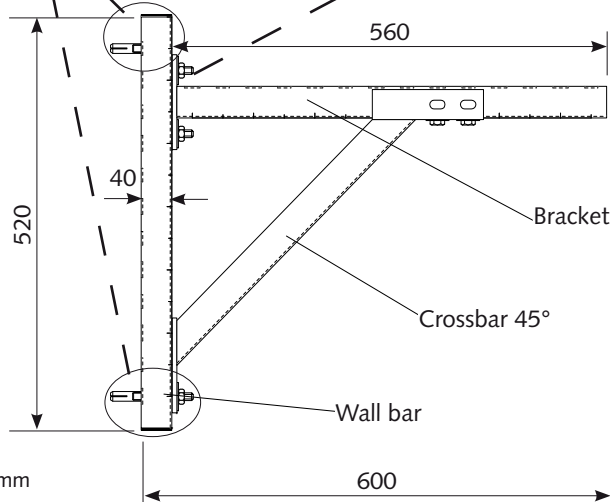
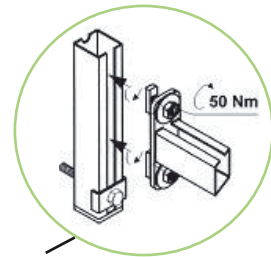
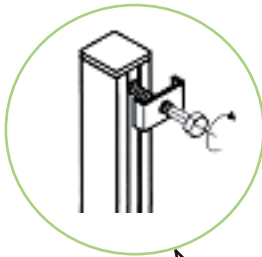
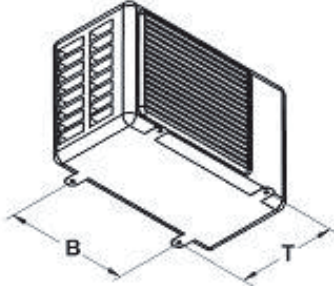

REMKO CONDENSATE CATCH TRAY WITH INTEGRATED OIL SEPARATOR



NOTE

Select the fastening material suitable for the wall to which the condensate catch tray is to be fastened!

Install the wall-mounted console to the building only where structurally permitted.

Make sure when drilling to place anchors that there are no supply lines where you are drilling.

The wall-mounted console must be fastened so that it can carry the weight of the unit. Make sure that no vibrations are transferred to the masonry. If necessary, install insulation (see accessory programme).

Refrigerant lines and electrical lines must be installed from the rear or from the right, **not from below!**

Install the outdoor unit on the wall-mounted console as follows:

1. Using suitable fastening material, install the unit on a wall designed to carry the load. Make sure that the height at which it is installed above the floor is adequate (above the expected snow level!).
2. Align the two wall rails in the distance of the mounting feet of the Outer part of the same amount on the wall (dimension B). Grasp the distance B measured best from the outdoor unit.



Take the clearance B figure directly from the outdoor unit between the left and the right wall-mounted consoles



The clearance required between the left and right wall-mounted consoles is indicated by the clearance B figure

3. Mark the locations of the holes for the dowel holes in the wall bars.
4. Drill the holes and fasten the wall bars with the corresponding wall dowel, the mounting screws and sheet steel angles on the wall.
5. Align the wall bars and correct any irregularities the wall, so that the wall bars hanging horizontal. Screw the Wall bars set and check everything for a tight fit.
6. Mount the bracket using the supplied T-head screws upper part of the wall bars (see drawing on page 9).
7. Align the bracket so that they are in a horizontal position before be fixed.
8. Mount the crossbar between wall bar and bracket (see drawing on previous page).
9. Mount the included brackets with vibrations dumpers on the both arms under the picture below.
Tighten the screws only slightly onto the hand, so that the Distances can easily bracket adjustment is need. The screws are easy to move by bars.
Mount the brackets with the vibrations dumpers at a distance of Mounting feet of the outdoor unit (dimension T) on the arm.

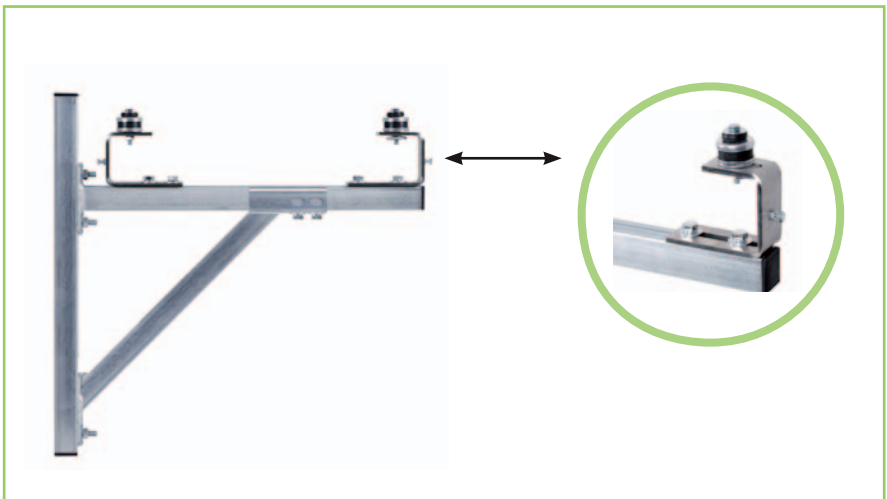

REMKO CONDENSATE CATCH TRAY WITH INTEGRATED OIL SEPARATOR

10. Now slide from between the condensate catch tray left or right between the pre-assembled brackets.

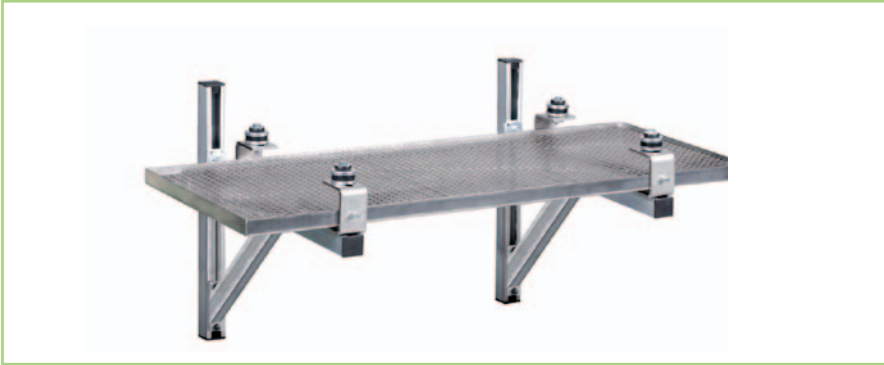

11. Place the outdoor unit to the pre-assembled vibration dampers and drag to the right brackets and all distances oriented further fastening screws securely. Secure the outdoor unit with the 4 screws (M6 x 50).



Delivery of the wall-mounted console (WKM 560 Plus)

Pos.	Description	Quantity
1	Wall bar	2
2	Bracket	2
3	Vibrations dampers with nuts	4
4	Sheet steel angle	4
5	T-head screws	4
6	Crossbar 45°	2
7	Connecting screws	4



NOTE

The vibration dampers are included in the standard scope of delivery for the wall-mounted consoles.

Installation in connection with floor consoles



Preparation

1. Align the two floor consoles at the same elevation, at the distance of the outdoor component's anchor feet, and at a 90° angle to the outdoor unit.
2. If necessary mark the positions of the bores at which the anchors for the floor consoles will be set (protection against tipping).
3. Drill the holes and secure the floor consoles using the appropriate anchors.
4. Align the floor consoles and correct for any unevenness in the surface so that the floor consoles stand horizontally.



NOTE

Make sure the surface is level and can carry the load!

An adequate surface is provided by two foundation strips or by securely anchored garden pavers (paving stones), set at the correct distance from one another. We recommend a gravel layer for the area between the consoles.

Make sure to provide for sufficient protection against tipping. Anchor the floor consoles to the surface if necessary!

*Refrigerant lines and electrical lines must be installed from the rear or from the right, **not** from below!*

REMKO CONDENSATE CATCH TRAY WITH INTEGRATED OIL SEPARATOR

Install the outdoor unit on the floor console as follows:

1. Set the floor consoles on a firm surface designed to carry the load.
Suitable surfaces are for example two foundation strips with a width of approx. 10 cm or securely anchored paving stones.
The surface must also be level and horizontal. Make sure the distance between the floor consoles on the left and on the right is adequate for the type of unit being installed. It is best to take the clearance figure directly from the outdoor component. The brackets with the rubber dampers included in the scope of delivery are placed on the two supports as shown in the illustration. First tighten the bolts lightly by hand so that the bracket clearances can be easily adjusted.

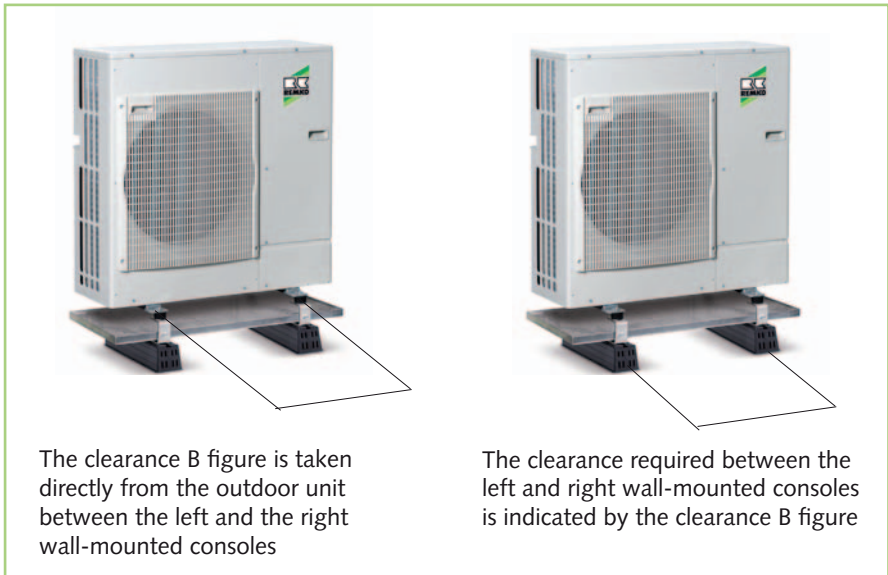
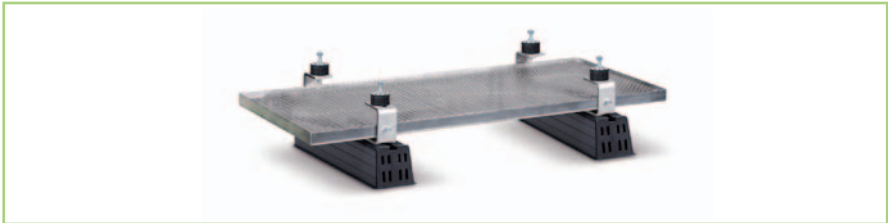

The clearance B figure is taken directly from the outdoor unit between the left and the right wall-mounted consoles

The clearance required between the left and right wall-mounted consoles is indicated by the clearance B figure

2. Now push the condensate catch tray from the left or from the right between the preinstalled brackets.

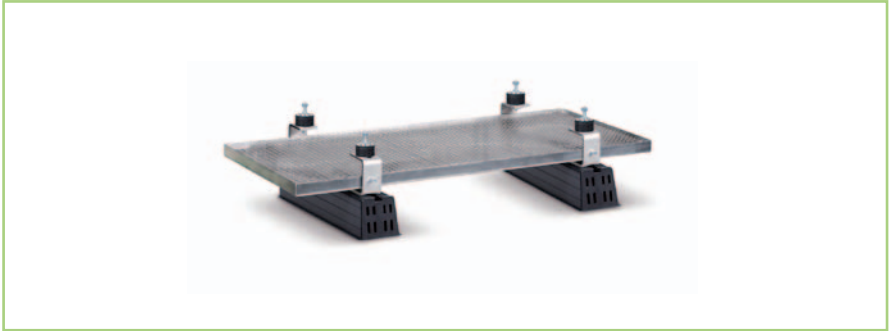

3. Set the outdoor unit on the preinstalled rubber dampers and pull them to the correct distance on the aligned brackets and tightly tighten all other bolts. Secure the outdoor unit with the 4 (M10 x 20) bolts included in the scope of delivery



Delivery floor console

Pos.	Description	Quantity
1	Floor console	2
2	Vibrations dampers with nuts	4
3	Fastening screws	8



NOTE

The vibration dampers are included in the standard scope of delivery for the floor consoles.

REMKO CONDENSATE CATCH TRAY WITH INTEGRATED OIL SEPARATOR

Draining water produced from defrosting or condensation (condensate)

Preparation

There is a 1" connection nozzle centred on the underside of the condensate catch tray over which the condensate or water produced from defrosting can be drained in a controlled manner. There are two versions for this:

from defrosting does not freeze while draining, the drain heater provided with the condensate catch tray must be inserted about 30 cm into the basic sewer pipe.

1. Draining over a trickle line

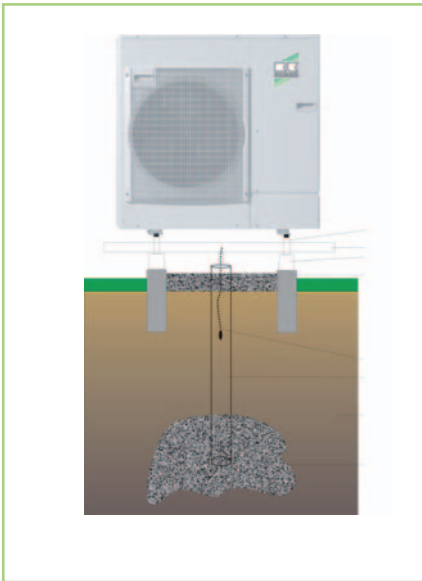

If the soil can absorb the seepage, the condensate or water produced from defrosting can be drained over a previously installed basic sewer pipe and gravel layer. Make sure that the end of the pipe is buried sufficiently deep. This must lie significantly below the frostline (approx. 1 metre deep). So that the condensate/water produced

2. Draining into the canalisation

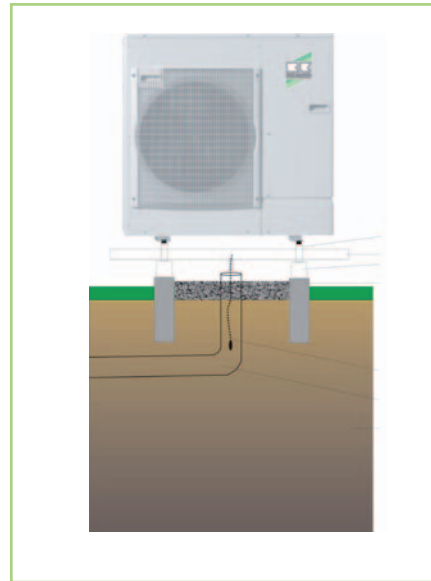

If there is a drainage canal in the area (e.g. rain gutter, the condensate or water produced from defrosting can be drained into this. Please pay attention to any requirement for a U trap (siphon).



NOTE

With extreme weather conditions, the condensation pan can freeze. This can be prevented by removing the leaf guard.

Connecting the electrical condensate drain heater

CMF / CMT 80 - 120

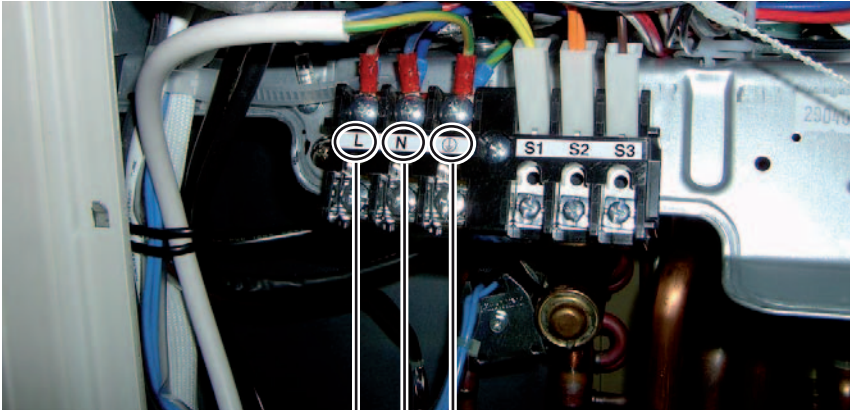

Connection: L N PE

Connection: L N PE

CMF / CMT 150 - 160

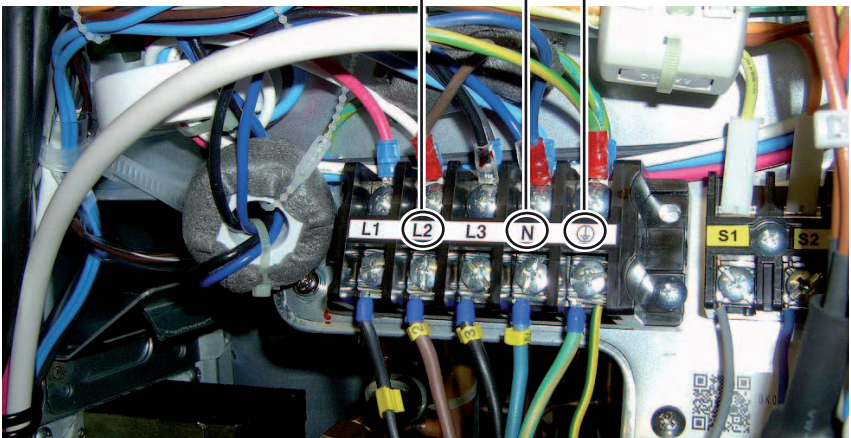

REMKO CONDENSATE CATCH TRAY WITH INTEGRATED OIL SEPARATOR

Earthing of the condensation catch tray

In order to earth the condensation catch pan, proceed as follows:

1. Take the earth cable with the earth clip and cable shoe (Figure 1) included in the scope of delivery and fasten the cable shoe to the M6 earthing screw (Fig. 2) mounted on the pan.

1 Earthing cable



2 Fasten the earthing cable to the pan

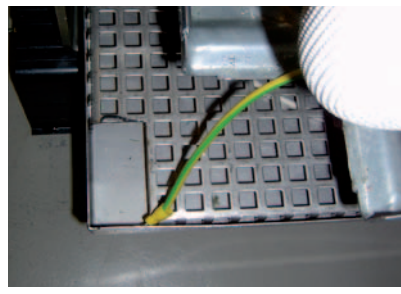

2. Attach the earthing clip in a suitable place on the inside of the galvanised base in the outdoor unit (see Figure 3).

3 Attach the earthing clip

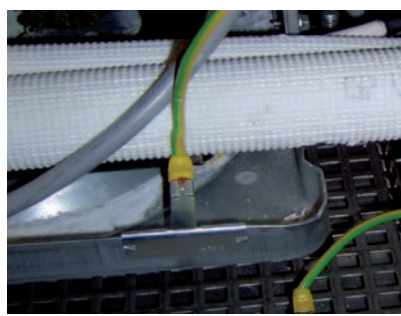

3. Re-assemble all side plates and commission the system.

⚠ CAUTION

Make sure when installing the outdoor component to provide for the minimum clearance specified in the operating manual.
In this case, the air intake side of the outdoor component (backside of the unit) requires a clearance of at least 200 mm.

💡 NOTE

Also observe the dimension drawings for the respective outdoor component in the respective installation manuals.

⚠ CAUTION

The condensate catch tray must be grounded!

Maintenance and Cleaning

Maintenance

The oil protector should be inspected and cleaned regularly. Leaves and other contaminants can, under certain circumstance, inhibit the function of the oil separator.

The water drain can be used to backflush the oil separator.

Immediately shut down the plant and check it for leaks if there are traces of oil in the oil protector.

Oil residue and oil traces must be disposed of correctly.

Cleaning

Immediately shut down the plant and check it for leaks if there are traces of oil in the oil protector.

Oil residue and oil traces must be disposed of correctly.

Please note that various cleaning agents dissolve oil in water. If this kind of cleaning agent is used, the oil protector must be flushed with water until there is no more cleaning agent in the oil protector.

Technical data

Condensate catch tray

Series		Condensate catch tray
Weight	kg	10.6
Width:	mm	1007
Depth:	mm	420
Height:	mm	60 with 1" drain nozzle 35 without 1" drain nozzle
Drain nozzle		centred
Rated capacity of the condensate drain heater	W	60
Length of the condensate drain heater	m	4
EDP no.:		260085

Wall-mounted and floor consols

	WKM 560	WKM 560 Plus	BK 120/160
Bracket	560 mm	560 mm	-
Wall bar	520 mm	520 mm	-
Total depth	600 mm	600 mm	1 m
Weight	2,2 kg	4,2 kg	5 kg
Loading weight max.	100 kg	200 kg	150
EDP no.:	260085	260078	260020

We reserve the right to make modifications to the dimensions and to the design which serve the ongoing technical development

REMKO INTERNATIONAL

*... and also right in your neighbourhood!
Benefit from our experience and advice*



REMKO GmbH & Co. KG
Air conditioning and heating technology

Im Seelenkamp 12
Postfach 1827
Telephone
Fax
e-mail
Website

D-32791 Lage
D-32777 Lage
+49 5232 606-0
+49 5232 606-260
info@remko.de
www.remko.de

