

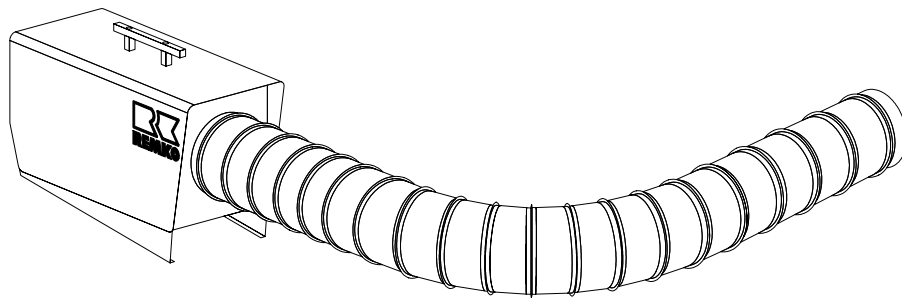

REMKO ELT 18-S / ELT 18-S E Electric Heaters



**Operation
Technology
Spare Parts**

Operating instructions

Make sure to read these instructions carefully before starting/using the unit!

Our guarantee will become void when the unit supplied by us is used and installed for inadequate purposes, or maintained incorrectly, etc., or if it is changed without our prior consent.

Subject to alterations!

Mobile Electric Heaters

CE

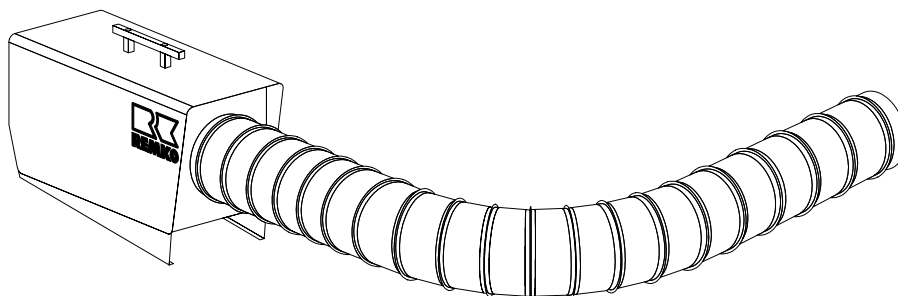

Contents	Page	Contents	Page
Safety Instructions	4	Service and guarantee	7
Description of device	4	Technical data	7
Starting	4	Exploded view	8
Unit shut down	5	Spare part list	8
Maintenance and service	5	Wiring diagram	10
Hot air distribution	6	Maintenance log	11
Troubleshooting	7		



Always keep these operating instructions near or on the unit!



Safety Instructions

REMKO electric heaters will provide you with high utility and long life thanks to our extensive material, function and quality controls. Dangers may arise nevertheless if the unit is used by persons not familiar with its operation or if the unit is not used for its intended purpose.

- ◇ The persons charged with the operation of the units have to check these before starting work as to visible defects of the operation and safety devices, as well as to make sure that no protective devices are missing. *In the case of faults the supervisor is to be informed.*
- ◇ In the case of faults which endanger the safe operation of the units, the units are to be stopped!
- ◇ During the operation of the units the applicable local regulations are to be observed and the relevant safety measures to be taken.
- ◇ Make sure that the prescribed safety distances from combustible objects are observed!
- ◇ A free air suction and air blow off must be ensured.
- ◇ Never place foreign objects into the unit.
- ◇ Do not cover the units during operation.
- ◇ The units may not be operated near bath tubs, showers, swimming pools, etc.
- ◇ The units may not be operated directly beneath a wall socket.
- ◇ The units may not be exposed to direct water jets.
- ◇ Make sure that no water penetrates inside the units.
- ◇ The units may not be operated in rooms which are endangered by explosions.
- ◇ Protect all electric cables outside the units from damage (e.g. caused by animals).

 **Connecting cable extensions may be laid exclusively by authorized electricians based on the unit capacity, cable length and taking the local terms of use into account.**

Description of Device

The units are operating with electric energy. They are specially designed for the usage of hot air hoses and for a fully automatic, all-purpose and simple application.

The units are equipped with capsuled electrical heating elements, noiseless maintenance-free axial fans, safety and after-cooling thermostat, thermostat socket and connecting cable with plug.

The units are in accordance with the basic safety and health requirements of the relevant EC – regulation.

The units are handled simply and are safe in operation.

Application

- ◇ Drying of new buildings, spot heating of working places outside or in fire-proof halls and production places.
- ◇ Permanent or temporary heating of rooms.
- ◇ Defrosting of machines vehicles and fire-proof storing goods with keeping the prescribed distance of safety.

Working of device

The units are equipped with a 4-stage operating switch. In the first stage only the supply air fan is operated and the units can be used for air circulation.

In the 2nd – 4th. stage the heating elements are activated and hot air is discharged.

The units can be operated with a room thermostat (accessories) which is ready to be plugged in, to ensure a constant room temperature. When the pre-selected temperature has been reached, the thermostat stops the heating operation to restart it when the temperature has fallen below the set value.

When the units have been switched off by the operating switch or the room thermostat, the supply air fan continues running for a certain time to cool down the heat exchanger, and then it stops automatically.

Starting

A well trained person is to be charged with the operation and control of the units.

 **The electric connection of the units is to be carried out via a special supply point with fault current safety switch.**

1. Check the main voltage is in accordance with the unit voltage.

<i>Electrical connection</i>	400 V 3 / N ~
<i>Frequency</i>	50 Hz
<i>Fuse protection (required)</i>	32 A (inert)

2. Put operating switch into position "0".

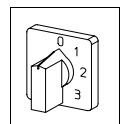

3. Connect the unit-plug to an adequate mains socket.

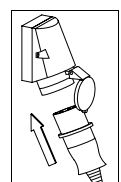

Switch settings

Operating switch
ELT 18-S

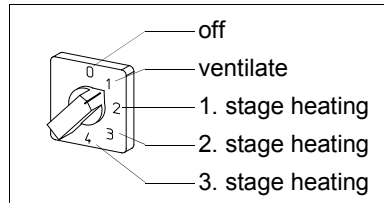

Ventilation

In this position only the supply air fan runs. The thermostat regulation and the heating operation is not possible.

1. Put the operating switch into position "1".

Heating without room thermostat

The unit runs under continuous duty.

1. Plug the supplied bridge circuit plug **2** into the thermostat socket **1** of the unit.
2. Put operating switch into desired position (2 or 3 or 4) depending on the desired heating capacity.

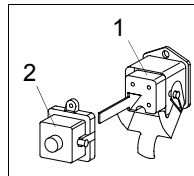



 **For optimum unit operation, the device should not be operated at an ambient temperature above 25 °C.**

Heating with room thermostat

The unit runs fully automatically and is dependent on set temperatures.

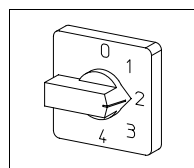
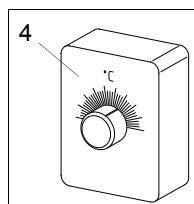
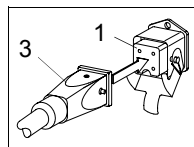
1. Remove the bridge circuit plug **2**.
2. Plug thermostat plug **3** of the room thermostat (accessories) into the thermostat socket **1**.
3. Put room thermostat **4** in a suitable place.
The thermostat sensor may not be exposed directly to the hot air current and not fixed directly on a cold surface.
4. Pre-select desired room temperature on the room thermostat.
5. Put operating switch into desired position (2 or 3 or 4) depending on the desired heating capacity.



 **If the temperature at the blower aperture rises above 100° C the heating operation is stopped.**

Unit Shut Down

1. Put operating switch into position "0".
OFF

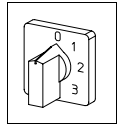

Attention, important hints to the after-cooling phase.

The air supply fan continues running to cool down the unit and then stops later.

Fan can start several times before final switching off.

 **Never interrupt (except in emergency situations) the connection to the mains before the end of the whole after-cooling phase.**
Our guarantee does not cover damages caused to the unit by overheating.

Maintenance and Service

Regular maintenance and the observation of some basic principles is important to ensure a long service life and a trouble-free operation of the unit.

 **Prior to starting any work make sure to pull the mains plug out of the mains socket!**

Please pay attention to the following points:

- ◇ The unit is to be maintained and cleaned in regular intervals.
- ◇ The unit is to be kept free from dust and other deposits and is to be cleaned only with a dry or humid cloth.
Do not use water jet.
- ◇ Do not use any aggressive cleaning agents or those which are harmful or environmentally unfriendly.
- ◇ Do not use cleaning agents which contain solvents.
- ◇ Only use suitable cleaning agents to remove extreme dirt.
- ◇ Check safety devices regularly.
Check protective suction and blower grids regularly and clean, when necessary.
- ◇ Do not damage the sensor and capillary tube of the thermostat when the protective blower grid is installed or removed.
- ◇ According to the terms of use the units are to be checked as to their perfect operation by an expert when necessary, but at least once a year.

 **Please carry out an electrical safety test after having finished service on the unit.**

Hot air distribution

The unit is equipped with a high efficiency axial fan.

The high efficiency axial fan permits operation with hot air hoses in different variants to transport the warmed air exactly and efficiently to the specific place.

Please observe the following instructions when hot air hoses are to be fitted:

- ◇ Please use exclusively those hot air hoses (accessories) which have been approved by our company.
- ◇ The internal overlapping at the seams must to point at air direction.
- ◇ Make sure that the hot air hoses are safely fastened to the outgoing air connection piece.
- ◇ The pipes and hoses may not have sharp kinks and bends in order to avoid heat accumulation.
- ◇ If the temperature at the blower aperture rises above 100° C the heating operation is stopped.
- ◇ A free air blow off must be ensured.

 **Due to the special high efficiency axial fan, the unit should not be operated without hot air hoses.**

Possible variations: (max. length 15 m)

Hot air hoses with \varnothing 305
maximal 2x 7,6m
with hose extension

Hot air hoses with \varnothing 203
maximal 2x 7,6m
with attachment

Hot air hoses \varnothing 305 in combination with \varnothing 203
maximal 1x 7,6m \varnothing 305 plus 2x 7,6m \varnothing 203
with attachment

REMKO spare parts:

Hot air hose \varnothing 305, 7,6m with sealing belt
EDV-No. 1099502

Hot air hose \varnothing 203, 7,6m with sealing belt
EDV-No. 1099501

Attachment with 2 outlets à \varnothing 203
EDV-No. 1099550

Hose extension \varnothing 305 with 2 sealing belts
EDV-No. 1009760

Assembly examples

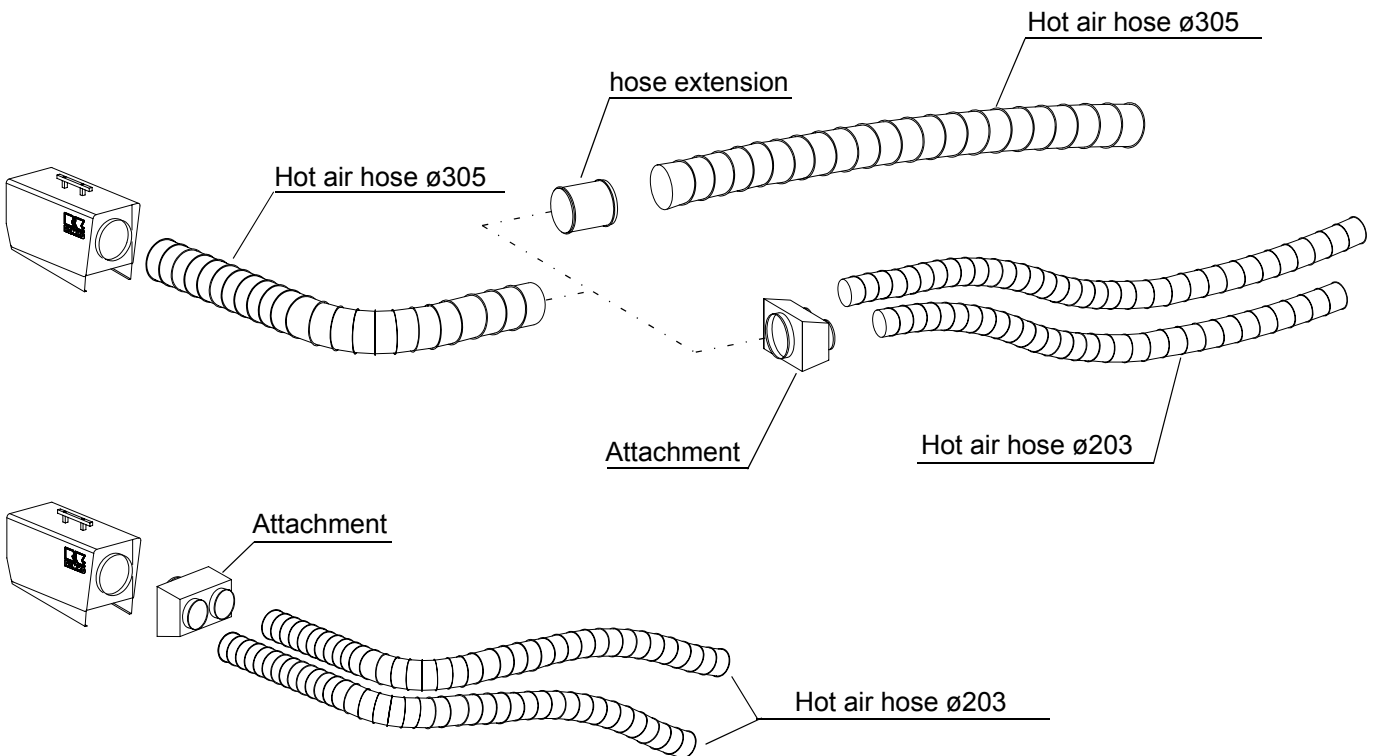

Troubleshooting

 **Prior to starting any work make sure to pull the mains plug out of the mains socket!**
Setting and maintenance is to be carried out only by authorised experts!

Unit (fan) does not start:

1. Check main fuse
2. Check connecting cable with plug
3. Check operating switch
4. Check slight drifting of fan (motor)

Unit does not heat

1. Check operating switch
2. Check contactor
3. Check function of temperature limiter resp. check capillary tubing (if damaged)
4. Check if thermostat plug resp. bridge circuit plug is coupled
5. Check thermostat-operation: thermostat must be set higher than the room temperature

Should the unit still not be working despite these checks, please contact an authorised service centre.

Service and Guarantee

Any claims under guarantee regarding materials can be accepted only when the orderer or his customer has filled in completely the "guarantee certificate" which is enclosed with every REMKO-heater and has returned it to REMKO GmbH & Co. KG in due time after the unit's sale and commissioning.

The units are factory tested on faultless function. If any failures occurs though which cannot be eliminated by the operating person, please contact your dealer or contact person.

 **An operation/use other than that indicated in these instructions is prohibited!**
In the case of non-observation we will not be held responsible and our guarantee will become void.

Correct usage

The units are to be used only for heating and ventilation purpose in industrial or commercial application because of their construction and equipment.

If specification of the manufacturer or legal regulations, are not followed or if unauthorised changes are made on the unit, the manufacturer is not liable for resulting damages.

Technical Data

Model	ELT 18-S / 18-S E		
Nominal heat output	kW	18	
Switchable heat output	kW	3 x 6	
Air output	m ³ /h	1600	
Electrical connection	V	400/3~	
Frequency	Hz	50	
Rated current max.	A	27,8	
Power consumption max.	kW	18,5	
Fuse protection (required)	A (inert)	32	
Sound pressure level L _{pA} 1m ¹⁾	dB (A)	72	
Sound pressure level L _{pA} 1m ²⁾	dB (A)	68	
Dimensions	Length	mm	750
	Width	mm	335
	Height	mm	500
Weight	kg	28,7	

1) noise measuring (without hot air hose) DIN 45635 - 01 - KL 3

2) noise measuring (with hot air hose) DIN 45635 - 01 - KL 3

Exploded View

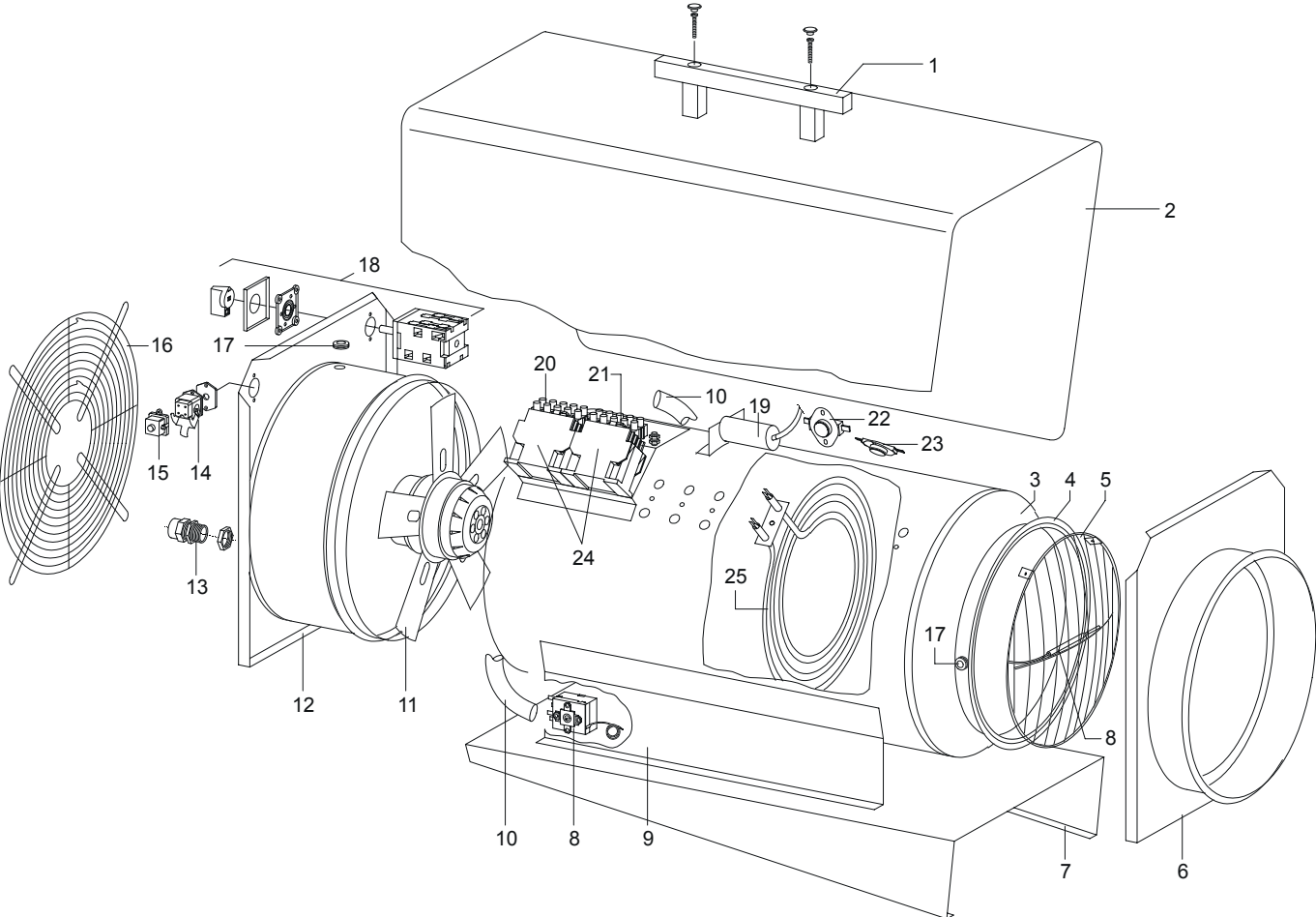

We reserve the right to make modifications in dimensions and construction in the interests of technical progress.

Spare Part List

No.	Description	Ref.-No.
1	transport handle	1101142
2	outside casing ELT 18-S	1107920
2a	outside casing ELT 18-S E (stainless steel)	1107919
3	inside casing with blow-out cone	1107953
4	cone gasket	1107954
5	blow-out protection grille	1101353
6	front panel with blow-out connection	1107930
7	base plate	1107950
8	temperature limiter with sensor	1107960
9	support bracket	1107922
10	protection hose	1107915
11	fan motor with blade	1107992
12	rear panel	1107931
13	traction relief	1107961
14	thermostat socket, cpl.	1101018
15	bridge circuit plug	1101019
16	air suction grille	1107994
17	protection socket	1101304
18	operating switch, cpl.	1107993
19	capacitor	1102716
20	terminal strip, 5 fold	1107952
21	terminal strip, 3 fold	1101373
22	temperature limiter	1101161
23	recool thermostat	1104065
24	contactor	1101021
25	heating element	1107998
not shown.	connecting cable with plug	1107962
	thermostat plug	1101020

When ordering spare parts it is necessary to indicate EDV-No. and machine no. (see data plate)!

Maintenance Log

Model:

Model No:

	1	2	3	4	5	6	7	8	9	10	11	12	13	14	15	16	17	18	19	20
Clean unit -surface-																				
Clean unit -interior-																				
Clean protection grille																				
Clean fan blade																				
Check safety facility																				
Check protection guards																				
Check unit for damage																				
Check fastening screws																				
Test run																				
Electric safety-inspections																				

Remarks:.....

1. Date: Signature	2. Date:..... Signature	3. Date:..... Signature	4. Date:..... Signature	5. Date: Signature
6. Date: Signature	7. Date:..... Signature	8. Date:..... Signature	9. Date:..... Signature	10. Date: Signature
11. Date: Signature	12. Date:..... Signature	13. Date:..... Signature	14. Date:..... Signature	15. Date: Signature
16. Date: Signature	17. Date:..... Signature	18. Date:..... Signature	19. Date:..... Signature	20. Date: Signature

Setting and maintenance work is to be carried out only by authorised specialists!

REMKO GmbH & Co. KG

Klima- und Wärmetechnik

D-32791 Lage · Im Seelenkamp 12

D-32777 Lage · PO Box 1827

Phone +49 (5232) 606 - 0

Fax +49 (5232) 606260

E-mail : info@remko.de

Internet: www.remko.de